

Brandt

Dear Customer,

You have just acquired a **BRANDT** washing machine and we would like to thank you.

We have invested all our dedication and know-how in this appliance so that it would best meet your needs. With innovation and performance, we designed it to be always easy to use.

In the **BRANDT** product range, you will also find a wide choice of ovens, microwaves, cooking hobs, ventilation hoods, cookers, dishwashers, driers, fridges and freezers that you can coordinate with your new **BRANDT** washing machine.

Visit our website www.brandt.com where you will find all of our products, as well as useful and complementary information.

BRANDT

www.brandt.com

As part of our commitment to constantly improving our products, we reserve the right to make changes to them based on technical advances to their technical and functional features and appearance.



Warning :

Before installing and using your appliance, please carefully read this Guide to Installation and Use, which will allow you to quickly familiarise yourself with its operation.

1 / PRESENTATION OF YOUR APPLIANCE	
• Safety recommendations _____	36
• Energy savings _____	37
• Protecting the environment _____	37
• Description of Your Appliance _____	38
2 / INSTALLING YOUR APPLIANCE	
• Removing the transport braces _____	40
• Setting up your appliance _____	42
• Connecting your appliance _____	43
3 / PREPARING YOUR LAUNDRY AND YOUR APPLIANCE	
• Textile care codes _____	44
• Treating stubborn stains _____	45
• Preparing your laundry _____	46
• Loading your laundry _____	47
• Loading detergents _____	48
4 / PROGRAMMING YOUR APPLIANCE	
• Description of the control panel _____	49
• Programming a wash cycle _____	49
• Programming a wash cycle with subsequent drying _____	51
• Programming a drying cycle only _____	51
• Operations possible during a program _____	52
• Programming examples _____	53
• Changing a program _____	54
• Details of programs _____	55
• Details of options _____	56
• Other functions _____	58
• Automatic safety features _____	58
5 / EVERYDAY MAINTENANCE OF YOUR APPLIANCE	
• Cleaning the detergent dispenser _____	59
• Cleaning the pump filter _____	59
• Access to the bottom of the tank _____	60
• Cleaning the drying filter _____	60
• Cleaning the appliance _____	61
• Miscellaneous maintenance _____	61
6 / INCIDENTS THAT MAY OCCUR - CAUSES & REMEDIES _____	62
7 / AFTER-SALES SERVICE _____	65

• SAFETY RECOMMENDATIONS



Important :

This appliance is designed for domestic use only, for washing, rinsing and spinning machine-washable textiles.

You must follow the instructions given. We decline any liability and warranty as a result of non-compliance with these recommendations, leading to material or bodily damage.

– This appliance is not intended for use by persons (including children) with impaired physical, sensory or mental capacities, or by inexperienced or untrained persons, except if they have been instructed in its operation by a person responsible for their safety.

– The appliance must be used only in accordance with the user manual to avoid damage to your laundry and your appliance. Use only detergents and care products that are approved for use in domestic washing machines.

– If, before washing, you treat your laundry with stain removers, solvents, or as a general rule any flammable products or highly-detonating products, do not place it immediately in the appliance (see chapter on "TREATING STUBBORN STAINS").

Similarly, use of solvents or aerosol products near your washing machine or any other electrical appliance in a poorly-ventilated room is strongly discouraged (risk of fire and explosion).

– If incidents occur and you cannot solve them via the solutions we have recommended (see chapter on "INCIDENTS THAT MAY OCCUR"), consult a qualified professional.

– Used appliances must immediately be made unusable. Disconnect and cut the power cord as close as possible to the appliance. Shut off the water supply and remove the hose. Make sure the door closure is unusable.

– If you need to open your machine during a cycle (e.g.: to add or remove laundry), depending on the current phase of the program (mainly during washing), exercise caution as the interior temperature may be high (risk of serious burns).

– At each new installation, the appliance must be connected to the water supply network using a new hose; the used hose should not be re-used.

Check the water supply and discharge hoses regularly; this could help prevent water damage.

– Do not allow children to play with the appliance and keep pets away from it.

• **For dryers :**

– Before drying, remove any powder or liquid detergent recipients that may have been placed in the drum with the laundry. The plastic material of these recipients would not withstand the drying temperatures.

– Never stop your appliance before the end of the drying cycle, unless you quickly remove all items and spread them out so that the heat is dissipated.

• ENERGY SAVINGS

- Only program pre-washing when absolutely necessary: e.g.: for very dirty sport or work clothes, etc.
- For lightly to moderately soiled laundry, a low-temperature program is sufficient to obtain a perfect wash result.
- For lightly soiled laundry choose a short wash cycle.
- Measure the detergent according to the hardness of the water, the degree of soiling and the quantity of laundry and follow the instructions on the detergent packaging.
- As soon as the cycle ends, "-0-" or "StOP" (depending on the situation) is displayed. You can program another wash cycle immediately. If you take no action this display remains visible for one hour. **After one hour with no action on your part, the display automatically switches off.** The machine will therefore use less energy. To reactivate the display, simply press one of the buttons. However, we recommend you select the "OFF" position to switch the machine off.

• For dryers :

- If you run a high-speed spin, the residual humidity is low, thus energy use is low. Even synthetic fibres must be spun before drying.
- If drying time is chosen carefully this can also save energy and water.
- To avoid wasting water and energy, do not over-dry your laundry.

• PROTECTING THE ENVIRONMENT

The packaging materials for your appliance are made from recyclable materials. Participate in recycling them and thereby contribute to protecting the environment by disposing of them in the municipal containers provided for this purpose.



Your appliance also contains many recyclable materials. It is therefore marked with this logo to indicate that, in European Union countries, used appliances must not be mixed with other waste. Appliance recycling organised by your manufacturer will thus be carried out in optimum conditions, in accordance with European directive 2002/96/CE relating to electrical and electronic equipment waste. Consult your local authority or your retailer to find the drop-off points for used appliances that is nearest to your home.

We thank you for your help in protecting the environment.

• DESCRIPTION OF YOUR APPLIANCE

- A** Control panel
- B** Lid opening knob
(remains locked during the cycle)
- C** Retractable front baseboard
(access to emptying filter /
access to transport braces)
- D** Front transport brace
- E** Baseboard removal bolts
- F** Lever for placement on rollers
- G** Height-adjustable front feet

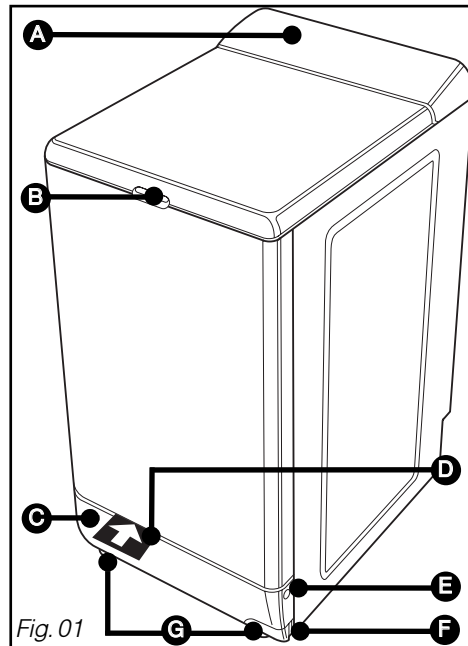

- H** Detergent dispenser
- I** Detergent dispenser unlocking
button
- J** Drying filter

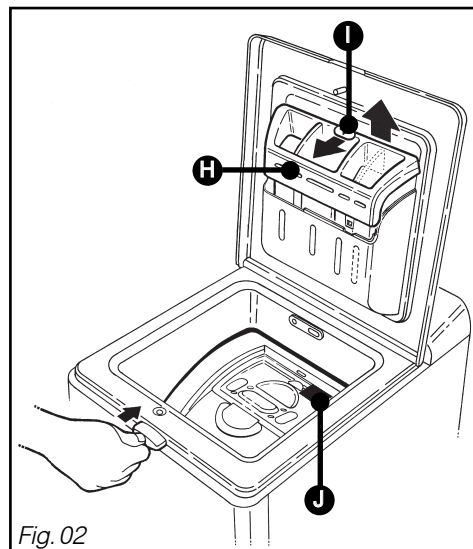

• DESCRIPTION OF YOUR APPLIANCE (continued)

- K** Emptying hose
- L** Electrical power cord
- M** Power cord bracing part
- N** Rear transport brace
- O** Bracing holes cover
- P** Water intake hose (according to model)
- Q** Rating Plate (after-sales reference)

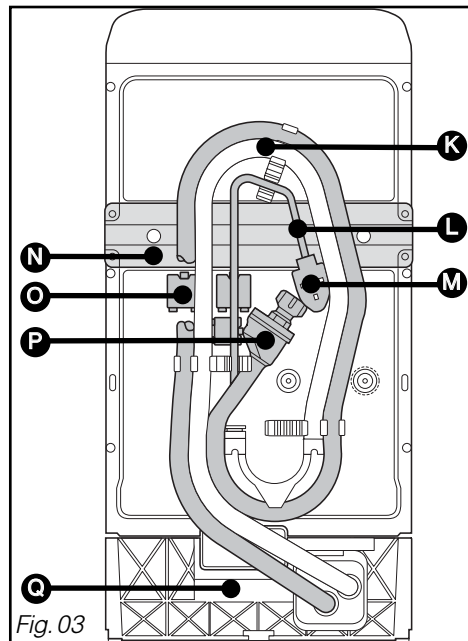

• REMOVING THE TRANSPORT BRACES

⚠ Important :
Before use, the following operations must be performed.

These operations involve removing all parts used to immobilise the tank of your appliance during transport.

These "brace removal" operations are necessary for the smooth operation of your appliance and compliance with current safety standards.

If these operations are not performed in full, this may cause serious damage to your appliance during operation.

Retirez préalablement la cale en polystyrène expansé située sous le couvercle.

• Front transport brace :

- Open by pressing on the bosses on each side of the **baseboard** at the same time **A** while pulling the baseboard towards you (Fig. 04).
- Using a 10 mm wrench, unscrew the "front" **brace** maintenance screw **B** made from red plastic (Fig. 05).
- Remove the "front" **brace** (Fig. 06).
- Plug the hole left by the brace using the **cover** provided **C** (Fig. 07).
- Reattach the baseboard (Fig. 07).

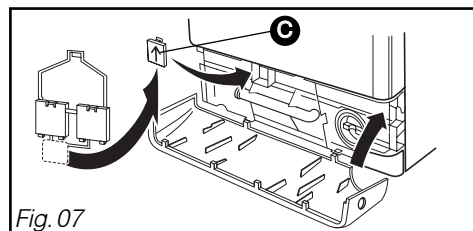
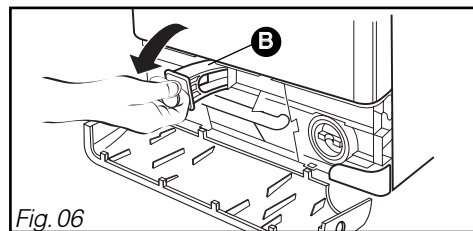
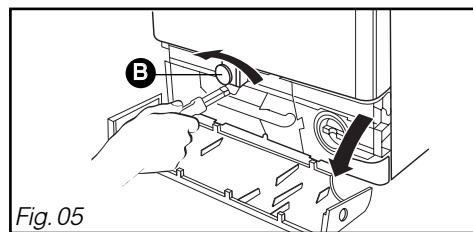
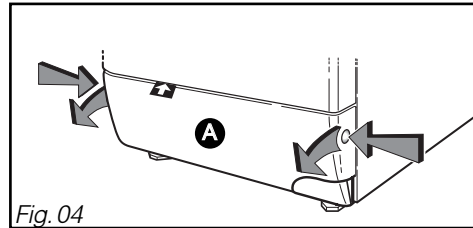

• **REMOVING THE TRANSPORT BRACES (continued)**

• **Rear transport brace :**

- Remove the 2 screws **D** and the 4 screws **E** using a 10 mm tube wrench or a flat head screwdriver (Fig. 08).
- Remove the brace **F**.
- Release the power cord from the plastic part **G** attaching the transport brace.
- Plug the holes left by the brace using the remaining 2 covers **H** (Fig. 09) and screw the 4 screws **E** back in their original position in the body.



Tip :

We recommend that you keep all parts for bracing as you will have to replace them if you need to move your machine at a later date.

All these parts, as well as those used for the entire machine are made from recyclable materials. Please consider this when disposing of them at the end of your machine's service life.



Information :

Before leaving the plant your appliance was thoroughly tested; therefore you may notice a small amount of water in the tank or in the detergent dispensers.



Information :

If you wish to place your appliance in line with your furniture units, you can break the hose attachment hooks.



Important :

Be careful not to crush the hoses.

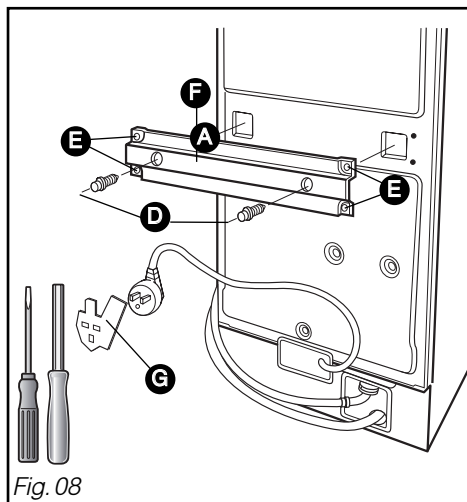

Fig. 08

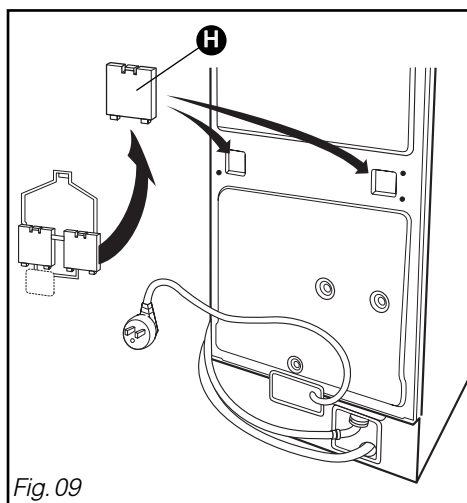

Fig. 09

• **SETTING UP YOUR APPLIANCE**

• **Placement on rollers :**

Your machine has retractable rollers so that you can move it easily.

To place it on rollers, turn the lever at the base of the appliance from the right to the extreme left (Fig. 10).

⚠ Important :
During operation, the machine must not rest on its rollers: do not forget to return the lever to its initial position.

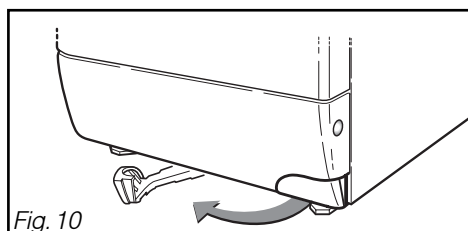

• **Levelling :**

Your machine is equipped with two adjustable feet in front to compensate for unevenness in the floor. To adjust horizontality and stability of the appliance, proceed as follows:

– Remove the baseboard (see Fig. 04, previous pages).

– Place the machine on rollers.

– Unscrew the 2 screws used to block the feet using a TORX T20 screwdriver (Fig. 11).

– Adjust the two feet using a flat head wrench or pliers to level the appliance.

– Put the appliance back on its feet and return the lever to its original position.

– Check the stability of the machine by pressing on the lid in a diagonal direction (direction AA then direction BB) (Fig.12). **There must be no visible movement of the appliance.**

– When the adjustment is correct, screw the 2 screws for blocking the feet and reattach the baseboard.

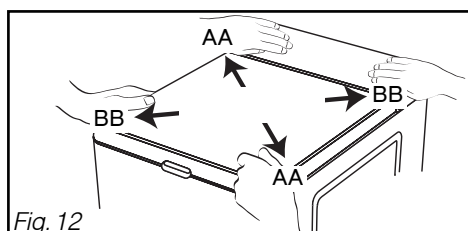
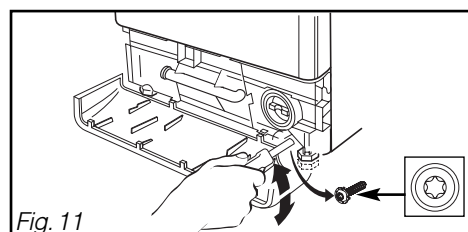

• **Environment :**

⚠ Important :
If you place your machine next to another appliance or piece of furniture, we recommend that you always leave a space between them to allow air to circulate.

🔍 Tip :
We strongly advise against installing your appliance :

- in a damp, poorly-ventilated room.
- in a place where it could be subject to water splattering.
- on a carpeted floor. If you cannot avoid it, take all precautions so as not interfere with air circulation at the bottom, to ensure good ventilation of the internal components.

• **CONNECTING YOUR APPLIANCE**

• **Cold water supply (Fig. 13) :**

- Connect the intake hose to a valve with a threaded end $\varnothing 20 \times 27$ (3/4 BSP).

Check presence of the seal.

Water intake :

- **Min. water pressure : 0,1 MPa or 1 bar**
- **Max. water pressure : 1 MPa or 10 bars**

• **Electrical power supply (Fig. 13) :**

The electrical installation must comply with the prevailing standards and the Electricity Board's regulations in the country concerned, **in particular for the earth electrode.**

We cannot be held liable for any incident caused by incorrect electrical installation.

Tip :
Tips for electrical installation of your appliance :

- Do not use an extension cord, adaptor or multiple plug.
- Never remove the grounding.
- The plug must be easy to access but out of the reach of children.

In the event of uncertainty, consult your installer.

• **Discharge of waste water (Fig. 13) :**

- Connect the emptying hose :
 - either temporarily, to a sink or bathtub
 - or permanently, to a ventilated siphon.

If your set-up does not have a ventilated siphon, ensure that the connection is not watertight.

In fact, to prevent waste water from returning to the machine, we strongly recommend leaving free space between the machine's emptying hose and the discharge pipe.

In any case, the emptying crosshead must be placed at a height of 0.80 m to 1.10 m in relation to the base of the machine.

Important :
Ensure the emptying hose is supported using an attachment to prevent the cross-head from coming off during emptying and causing a flood.

Important :
Your appliance complies with European directives 2006/95/CE (low voltage directive) and 2004/108/CE (electromagnetic compatibility).

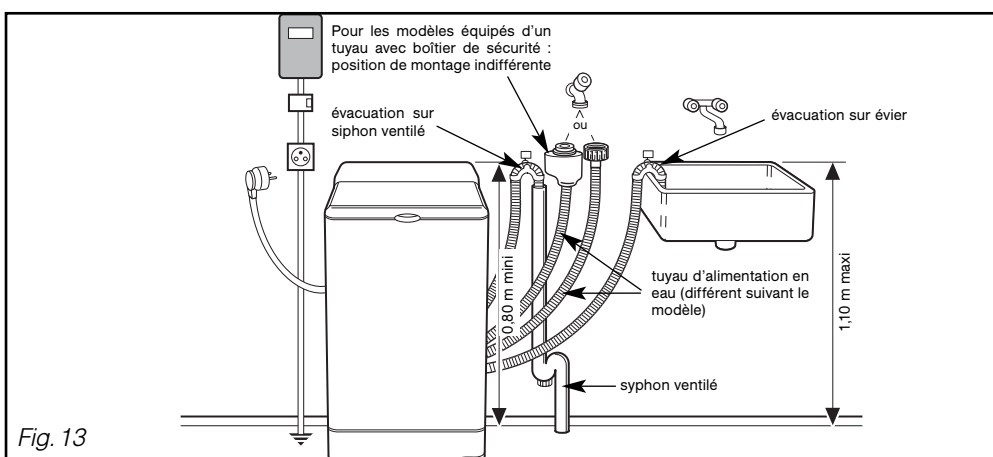

Fig. 13

• TEXTILE CARE CODES



Tip : To help you care for your textiles, they have a label giving the necessary information. They are expressed in codes by the symbols below:

WASHING		USE OF BLEACH	
	Maximum temperature : 95°C - Normal mechanical action - Normal rinse - Normal spin		
	- Reduced mechanical action - Rinse at decreasing temperature - Reduced spin	Bleach permitted: diluted and cold	No bleach
IRON			
200 °C High setting	150 °C Medium setting	110 °C Low setting	No iron (no steam)
DRY CLEAN			
All usual solvents	Tetrachloroethylene mineral spirits	Mineral spirits and F113 fluorinated solvent	No dry clean, no stain remover with solvents
Normal process			
	- Reduced mechanical action - Reduced drying temperature - No addition of water (Self-service cleaning impossible)		
DRYING IN TUMBLE DRYER			
High tumble dry	Low tumble dry	Do not tumble dry	

© COFREET



Important : Before the first wash, we recommend running a "COTTON 90° without pre-wash" cycle without load, using 1/2 the usual detergent quantity. This will eliminate any manufacturing residue that may be left in the machine.

• TREATING STUBBORN STAINS



Tip :

Perspiration, blood, fruit, wine and chocolate stains generally come out with biological detergents, but other stains require specific treatment before machine washing. First conduct a test on an inconspicuous part of the textile and rinse thoroughly. If you use a stain remover, always start on the outside of the stain to prevent ring marks.

CANDLE WAX: remove the excess of the stain by scraping. Then place absorbent paper on either side of the fabric and run a warm iron over the stain to melt the remaining wax.

COFFEE - TEA:

- on white cotton: blot the stain using hydrogen peroxide* before normal washing
- on coloured cotton: blot the stain using a vinegar/water solution (2 tbsp white vinegar for 1/4 litre of water) before normal washing
- on wool: blot the stain using a combination of equal parts alcohol* and white vinegar before washing the item.

SLUDGE - TAR: use Eau Écarlate* stain remover or otherwise, spread a little butter on the stain, leave to penetrate then blot with turpentine* spirits.

CHEWING-GUM: chill it using an ice cube. As soon as it is hard enough, scratch it with your nail. Remove the remaining ring using a degreasing agent*.

CHOCOLATE - FRUIT - FRUIT JUICE - WINE: blot the stain using a vinegar/water solution (2 tbsp white vinegar for 1/4 litre of water). Rinse well and wash normally.

BALLPOINT PEN - MARKER PEN: remove as much ink as possible by blotting the stain with absorbent paper. Place a clean cloth behind the stain and blot the stain using another cloth soaked in white vinegar for synthetic and artificial fibres or 90* alcohol for other fibres (if the textile allows).

GREASE: immediately sprinkle the fabric with talc. Leave to dry and brush gently to remove the talc. Then blot using a degreasing agent such as mineral spirits*. Rinse and wash normally.

GRASS: blot the stain using white vinegar or 90* alcohol (if the textile allows) then rinse and wash.

KETCHUP - TOMATO SAUCE: prepare a solution with one part glycerine for one part hot water. Let the item soak for an hour, then wash normally.

PAINT: do not let paint spots dry. Treat them immediately with the solvent indicated on the paint pot (water, turpentine*, white spirit*). Soap then rinse.

MAKE-UP: place the stained side of the fabric on absorbent paper, then dampen the other side of the fabric with 90* alcohol if the item allows and if the stain is not greasy. Otherwise, use a degreasing agent (such as trichloroethylene*).

RUST: for slight stains, cover with salt, squeeze lemon juice on the salt and leave overnight; then rinse thoroughly and wash. For heavier stains, use a rust removal product and follow the manufacturer's instructions carefully.

BLOOD: soak the stained item as promptly as possible in cold salty water, then wash normally.

• Use of stain removers



Important :

To avoid risk of fire and explosion: () if you use the products recommended in the recipes above, take care to rinse your laundry thoroughly before placing it in your machine - if you use commercial stain removers, follow the manufacturer's recommendations carefully. We remind you that, generally speaking, stains that are treated promptly are easier to remove. However, old stains that have been ironed or dried in tumble dryers cannot be removed.*

• PREPARING YOUR LAUNDRY

• **Sorting your laundry :**

Refer to the textile care codes table for sorting your laundry and choose the program that best suits the labels. For mixed loads, use the program suited to the most delicate laundry. For new laundry, take the precaution of checking that the fabric does not bleed: see "**Colour test**" opposite.

• **The colour test :**

At the first wash, coloured laundry often bleeds, except if it is guaranteed colourfast. Before placing it in the machine, perform the following test:

- Take an inconspicuous part of the item
- Dampen it using hot water
- Then press it against a white cloth
- If the colour does not bleed, you can wash it normally in the machine.
- If the colour does bleed, wash it separately in the machine or by hand.

• **Laundry loads**

 **Important :** For optimum results, do not overload the drum and do not exceed the following maximum loads :

Cotton/Colours _____	6 kg
Mixed _____	3 kg
Delicates/Wool _____	2 kg

Average weight of some items of "light" dry laundry

Single sheet _____	400 to 500 g	Cotton t-shirt, large size _____	150 g
Double sheet _____	800 g	Dish towel _____	100 g
Pillowcase _____	200 g	Tablecloth _____	250 g
Light night shirt _____	150 g	Delicate lingerie _____	50 g
Child's plain weave trousers _____	120 g	Child's synthetic woollen items _____	50 g
Adult's plain weave trousers _____	500 g	Sock _____	20 g
Cotton/polyester men's shirt _____	200 g	Adult's plain weave pyjamas _____	250 g

Average weight of some items of "heavy" dry laundry

Adult's jeans _____	800g to 1 kg	Child's terry pyjamas _____	100 g
Large bath towel _____	700 g	Bathrobe _____	1200 g
Small towel _____	300 g	Sweat shirt _____	250 g
Adult's sweat pants _____	350 g	Quilt cover _____	1500 g

• **Checking your laundry**

 **Important :** Failure to follow these recommendations can cause serious or even irreversible damage (damaged drum, torn laundry, etc.) and will void the warranty.

- Empty pockets: remove all objects such as lighters and matches, etc.
- Close zippers and press fasteners.
- Remove hooks from net curtains or place your net curtains in a washing bag.
- Remove poorly-attached buttons, pins, clips.
- Place small items of laundry (ribbons, pouches, etc.) in a washing bag.
- Turn multi-layer garments inside out (sleeping bag, anorak, etc.).
- Turn knits, fabrics with embossed decoration, trousers and stitched garments inside out.

• PREPARING YOUR LAUNDRY (continued)

• Checking your laundry before drying

The fibres in your laundry are of varying types and origins; their reaction to drying is therefore very variable

Generally speaking, all machine-washable fabrics may be dried in a tumble dryer except for :

- wool, silk, netting and nylon tights or stockings
- plasticised fabrics
- chlorofibres (Thermolactyl* for example)
- laundry items with plastic foam, rubber or reinforcements that would be likely to become detached

- bulky items (quilts, eiderdowns, etc.)
- unwashed or unspun laundry
- laundry that has been cleaned using chemicals

⚠ Important :
Avoid drying light textiles and heavy cotton textiles together as the weight of the heavy fabrics crushes the lighter ones.

⚠ Important :
It is preferable to dry non-colourfast fabrics separately.

* : Registered trademark

Substances contained in soiling such as cooking oil, acetone, alcohol, petrol, kerosene, stain removers, turpentine or wax must be removed before drying in your machine (by using an adapted warm water washing program with additional detergent for example).

• LOADING YOUR LAUNDRY

Conduct operations in the following order:

• Opening the machine

- Check that the machine is switched off.
- Press the knob located at the front of the machine. The lid opens.

• Opening/Closing the drum

- Open the drum by pushing on the knob located on the front door (Fig. 14).
- To close them again, push the front door downwards then close the rear door on top, until it locks.

⚠ Important :
For correct locking, check that the blue edging **A** of the knob is visible (Fig. 15).

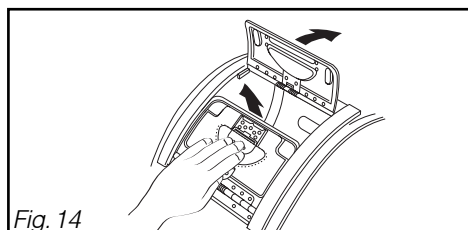

Fig. 14

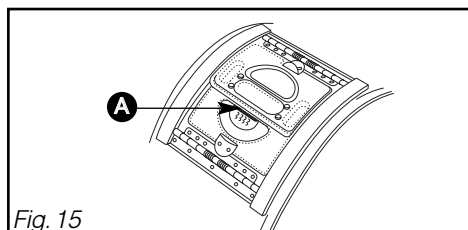

Fig. 15

• **LOADING YOUR LAUNDRY (continued)**

To achieve the best washing performance, after sorting and unfolding, place the laundry in the drum, not piled up but spread out evenly. Mix large and small items to achieve the best spinning, so there is no imbalance.



Important :

When closing the drum, be careful not to trap laundry between the two doors.

• **LOADING DETERGENTS (Fig. 16)**

• **Measuring the detergent**

The quantity of detergent to be used depends on the hardness of the water, the degree of soiling of your laundry and the size of the load.

Always refer to the quantity recommendations given on the detergent packaging.

Warning: the recommendations of detergent manufacturers are usually for a drum filled to the maximum. Adjust your quantity in accordance with the weight of laundry in the machine.

These recommendations will prevent excessive use of detergent which causes foaming. Over-production of foam can decrease the performance of your machine and increase the wash duration and water use.

• **Detergents for woollens and delicate fabrics**

When washing these fabrics, we recommend using a suitable detergent (avoid putting it directly in the drum as some of these products are aggressive to metal).

• **For dryers :**

Always adhere to the manufacturer's instructions when using softening products:

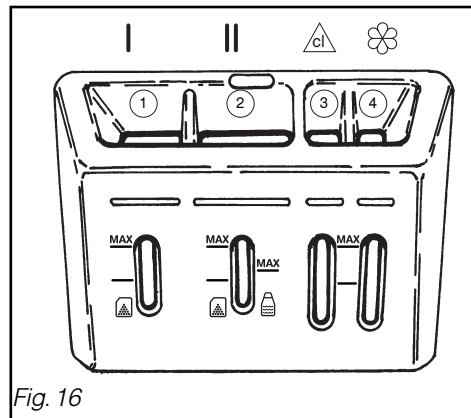

Fig. 16

- ① | Pre-washing compartment (powder)
- ② || Washing compartment (powder or liquid)
- ③ Bleach compartment
- ④ Fabric softener compartment
- Powder detergent
- Liquid detergent



Important :

- The "WASHING" compartment may contain powder and liquid; however, do not use liquid detergent for programs **WITH** pre-washing or **WITH** "delayed start" (depending on model).
- For correct filling of detergent compartments, place the lid in its maximum opening position.
- Do not exceed the **MAX** level.

• DESCRIPTION OF THE CONTROL PANEL

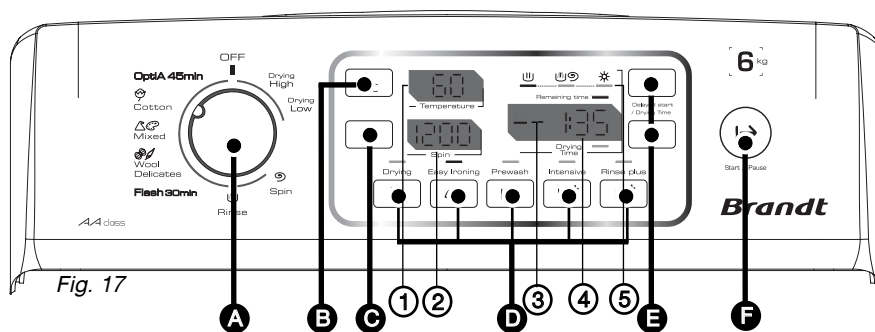

Fig. 17









- A** Program selector
- B** Temperature setting
- C** Spin speed setting
- D** Options and Child Safety Selection buttons
- E** Delayed start
- F** Start/Pause
- 1** Temperature display
- 2** Spin speed display
- 3** Child Safety lock indicator light
- 4** Time display
- 5** Cycle sequence indicator lights

NB : All buttons are touch-sensitive; they do not press down. A simple touch is sufficient.

• PROGRAMMING A WASH CYCLE

Operations to perform	Display
– Choose the wash cycle best suited to the type of laundry by turning the program selector A . NB : Turning the selector to a position other than “OFF” switches the machine on.	The machine displays the most suitable spin speed for the program chosen as well as the duration of this program for a standard load.
– Choose the washing temperature best suited to the type of laundry using the temperature B button. NB : For a cold wash cycle, change the temperature by selecting “0” on the display 1 .	
– You can change the spin speed proposed using the Spin C button. – Or for the end of cycle : choose drain . The cycle will end with draining at 110 rpm without spin. – Or : full tank stop . Your machine will stop with a tank full of water before the final spin.	

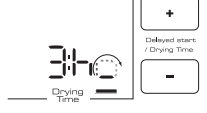
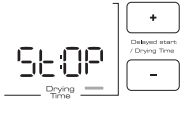
• PROGRAMMING A WASH CYCLE (continued)

• Operations to perform (continued)	Display
<p>– If necessary choose options using the D buttons. (see chapter “DETAILS OF OPTIONS”).</p> <p>Information :  You can select only the options compatible with the program chosen.</p>	<p>Light on: option selected Light off: option not selected</p> <p>  NB : Choosing an option changes the cycle duration.</p>
<p>– Choose immediate start by pressing the “Start/Pause” I → F button ...</p> <p>The cycle sequence indicator 5 lights up. The program begins.</p> <p>NB : The duration displayed at the start of the program is for information only. It will re-adjust a few minutes after the cycle begins following estimation of the laundry load.</p>	<p>Throughout the cycle, the machine indicates the current phase of the cycle...</p> <p>  </p> <p>... as well as the estimated time remaining until the end of the cycle.</p> <p>Remaining time 2:10 2:10 = 2h10 (hour - minutes)</p>
<p>– Or choose to delay your cycle by pressing the “Delay Start” (+) or (-) buttons E (refer to the chapter on “OTHER FUNCTIONS” - “Delayed start”).</p>	<p></p> <p>A moving display (four little revolving segments) shows the period of time until the cycle starts.</p>
<p>• Indication of End of cycle</p> <p>NB : After the spin, your washing machine automatically cools the laundry and positions the drum with the opening at the top for easier access to the laundry. This operation lasts 3 minutes maximum.</p> <p>The display 4 then shows “STOP”, which tells you the cycle has finished.</p> <p>– Turn the program selector A to the “OFF” position You can then open the lid and remove your laundry.</p>	<p>Display</p> <p></p>
<p>• Cancellation during programming, washing or during pause</p> <p>– Turn the program selector A to the “OFF” position</p> <p>NB : Cancellation means you always have to re-program from scratch. If you have cancelled during washing, if you need to drain the water, run a “Spin”  program and set a suitable speed.</p>	<p>Display</p> <p>All displays are extinguished</p>

• PROGRAMMING A WASH CYCLE WITH SUBSEQUENT DRYING

Your appliance lets you run a drying cycle straight after a washing cycle with **automatic detection of the end of drying**. This option always uses **HIGH drying temperature**.

NB: Results obtained may vary somewhat depending on the type of laundry load.

• Operations to be perform

- Program your **wash cycle** (see previous pages).
- Select the **"Drying"** option using the option ☀ **D** button.
- Press the **"Start/Pause"** button |→ **F**. The cycle starts.

⚠ Important :
To ensure proper drying, the load must not exceed 4 kg.

If the machine estimates that the load is too large to permit subsequent drying, it stops at the end of the wash cycle and informs you via the figure "4" flashing on the **display** ②. In this case, adjust the laundry load, and press the **"Start/Pause"** button |→ **F** to resume drying. If you decide to leave only a small load of washing, you must adjust the drying time beforehand using the (+) or (-) buttons **E** and start the cycle again by pressing the **"Start/Pause"** button.

Display

(The indicator for the **"Drying"** option lights up)
 The time displayed includes estimated drying time.

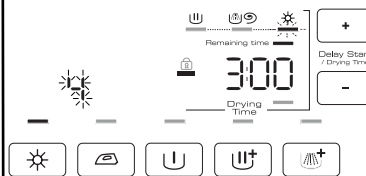

• PROGRAMMING A DRYING CYCLE ONLY

If your laundry load is too large to permit subsequent drying, or if you wish to dry only part of the load, you may select drying to machine dry only the desired items, adjusting the duration to the type and quantity of laundry.

• Operations to be perform

- Turn the **program selector** **A** to choose your **"High"** or **"Low"** drying program according to the type of laundry.
- Select a drying time using the (+) or (-) button **E**.
- Press the **"Start/Pause"** button |→ **F**. The cycle starts.

NB: First ensure :
 - that the water valve is open.
 - that the load has been sufficiently spun (at least 1000 rpm) and that it does not exceed half a drum.

A delayed start for drying alone is not possible.

Display



The **"Drying"** indicator lights up.

• OPERATIONS POSSIBLE DURING A PROGRAM

• Add or remove an item during the cycle (not possible during spin)

– Press the "Start/Pause"  button to interrupt the wash cycle.

– Add or remove the item(s) of laundry
The time taken for the lid to unlock depends on the temperature inside the machine and, for safety reasons, this may take several minutes if interrupting a cycle at more than 40°C.

– Press the "Start/Pause"  button to continue the cycle.

Display

The time countdown stops. The cycle sequence and "Remaining time" lights flash alternately.



Remaining time: 

Countdown starts again and indicator lights "steady" again.



Remaining time 

• Changing the program during the cycle



– During the cycle or during the delayed start, you can make certain program changes if needed.

To find out which program changes are possible, refer to the chapter on "CHANGING A WASHING PROGRAM".

Display

• Child safety device

– To avoid unintended changes during a program, you have the option to activate the "Child safety" device.

To do this, press on the 2nd and 4th option buttons  at the same time (the "Padlock"  indicator comes on).

When the "Child safety" is activated, the buttons and program selection are locked.

– If you wish to change your program, you must first deactivate the "Child safety" device.

To do this, press on the same 2 buttons at the same time, until the "Padlock"  indicator goes off.

NB : You can activate or deactivate the "Child safety" device at any time. Of course, we recommend that you activate it only after programming and launching the cycle.

Display

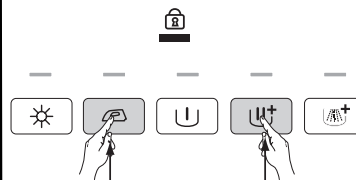

 **Important** : At the end of the drying cycle, remember to clean the drying filter (refer to the chapter on "EVERYDAY MAINTENANCE OF YOUR APPLIANCE").

• **EXAMPLES OF PROGRAMS**

To choose the most appropriate program for your load, follow the indications given on the labels attached to most textiles.

Table of programs Textile type	Temperature (°C)	Max. dry load for wash (kg)	Duration Excluding Option (hour - minutes)	Possible options					Max. load for drying (kg)	Subsequent tumble dry Duration (*) Washing + Drying (hour - minutes)
				Prewash	Intensive	Rinse plus	Easy Ironing	Drying		
COTTON / WHITES / COLOURS	- 90°	6	2 - 2 1/2 hrs	●	●	●	●	●	4	5 to 5 1/2 hrs
MIXED	- 60°	3	1 3/4 to 2 hrs	●	●	●	●	●	3	3 3/4 - 4 hrs
DELICATES / WOOL	- 30°	2	30 to 45 mins			●			Prohibited	
Specific programs										
OptiA 45min	- 40°	3	45 mins			●		●	3	3 to 3 1/4 hrs
Flash 30min	- 40°	3	30 mins					●	3	2 3/4 hrs
RINSE			20 mins					●	This program ends with a spin.	
SPIN			10 mins						Choose the max speed the laundry can withstand.	
Drying programs										
"High" tumble dry : COTTON / WHITES / COLOURS			20 mins to 3 hrs					●	4	Select a drying duration.
"Low" tumble dry : SYNTHETICS / DELICATES			20 mins to 3 hrs					●	3	

- : These functions may be used alone or together – **illogical combinations are impossible.**
- For an explanation of the different programs, refer to the chapter on "DETAILS OF PROGRAMS".
- (*) : The times displayed at the start of the program are based on a full load. They are readjusted during the cycle, according to the load of laundry in the drum.
- NB** : For testing institutes : **OptiA 45min** = Short cotton program at 40°C.

Information :
Choosing an option changes the cycle duration, for example:
 – Prewash option: the cycle is extended from 17 to 33 minutes.
 – Rinse plus option: the cycle is extended from 9 to 18 minutes.

• CHANGING A WASH PROGRAM

• During programming

All program changes are possible as long as you have not yet pressed the "Start/Pause" \rightarrow **F** button.

• After the cycle starts

After pressing the "Start/Pause" button \rightarrow **F** if you wish to change the type of textile (for example from "Cotton" to "Mixed", etc ...), you must cancel the current program. To do this, turn the program selector **A** to the "OFF" position. Then program your new choice and remember to confirm by pressing the "Start/Pause" button \rightarrow **F**.

NB : If you change a program without cancelling, the machine displays the following:



This indicates that the new selection will not be recorded.

However, the current cycle is not cancelled and if you return the program selector **A** to its original position, the cycle will resume its normal course.

• Any time during the cycle

Depending on your model, the following changes are possible without pressing the "Start/Pause" button \rightarrow **F**.

– You can change the washing temperature for the same type of fabric.

NB : If the temperature reached by the washing cycle is higher than your new choice, heating of the water stops immediately and the cycle continues.

– You can change the spin speeds.

– You can select "Drain" or "Full tank stop" at any time during washing.

– You can activate the  (Rinse plus) option at any time until the start of the rinse phase (until the "Rinse" light comes on).

– You can deactivate all the options at any time during the cycle as long as their action is not already complete.

• During the period preceding the actual start of the cycle (when you have chosen to delay the wash cycle).





– All program changes are recorded during the wait period before a delayed start.

– You can change the duration of the "Delayed Start" at any time during the wait period preceding the actual start of the cycle. To do this, press the Delay start (+) or (-) buttons **E** to choose a new value.

NB :

– During this period, the choice of a new time cancels the previous selection. The new duration chosen is recorded as of the latest selection.

– If during this period you wish to completely cancel the "delayed start", press one of the Delay start (+) or (-) buttons **E** until the "Drying time" light goes off and the "Remaining time" light comes on. Then, briefly press the "Start/Pause" button \rightarrow **F**. The cycle will start immediately.

– You can activate or change the  (Easy Ironing),  (Prewash),  (Intensive),  (Rinse plus) and  (Drying) options at any time during the wait period before a "Delayed start".

• At the end of the cycle

When the machine displays "StOP" you can program a new cycle without returning the program selector **A** to the "OFF" position. The machine is then ready to be reprogrammed.

• DETAILS OF PROGRAMS

• Wash programs

• OptiA 45min

This 40°C max program lets you wash a usual 3kg load of cotton and mixed items in 45 minutes "flat", guaranteeing perfect washing results and maximum energy savings.

• Cotton

For a load comprising COTTON (white resistant or colour items).

! Important :
If you are washing colours, do not exceed 60°C max.

NB : During the first minutes of this program, your washing machine automatically estimates the load of laundry placed inside. It adjusts water usage and program duration accordingly for perfect washing results. Thus the remaining time displayed may vary considerably once this measurement has been made.

• Mixed

For a load comprising RESISTANT SYNTHETICS or MIXED FIBRES.

• Delicates / Wool

For a load comprising NET, DELICATE FABRICS, FRAGILE ITEMS and "MACHINE-WASHABLE" wools.

Nota : Program with low mechanical action, very low spin and agitation action adjusted to suit these fabrics.

• Flash 30min

This program at 40°C max lets you wash a 3 kg load of lightly soiled laundry comprising COTTON, WHITES, COLOURS or RESISTANT SYNTHETICS.

Its duration is just 30 minutes.

• Wash programs (continued)

• Spin

This program lets you spin the laundry at the speed of your choice. It is followed by emptying.

• Rinse

Rinse followed by, on selection:

- spin with emptying,
- emptying only ("Draining" option),
- a full tank stop.

! Important :
With a "rinse only" followed by spin or "spin only", be careful to choose the appropriate spin speed for the type of laundry in the machine.

• Drying programs only

• High tumble dry ^{Drying High}

Lets you dry a cotton load (max 4 kg) which has been previously spun. Choose a duration suitable for the load and the degree of drying desired.

• Low tumble dry ^{Drying Low}

Lets you dry a load of synthetics or mixed fibres that withstand tumble-drying at reduced temperature..

NB : Avoid using this program for resistant fabrics.

! Information :
During drying programs, the "Drying" option button is automatically selected and cannot be unlocked.

! Information :
The drying programs finish with a cooling cycle that lasts for a few minutes to allow the washing to cool gradually.

• DETAILS OF OPTIONS

• **Prewash**

Specially designed for soiled laundry (mud, blood, etc.).

Cold agitation precedes a heating phase 30°C. This cold agitation helps remove the stain particles before heating.



Important :

In this case, it is necessary to also place detergent in the "I" compartment of the detergent dispenser.

• **Intensive**

This function improves washing performance and by automatically increasing the temperature of the wash water and the agitation time, it treats stubborn stains.

• **Rinse plus**

"Sensitive and allergic skin cycle": adds an extra rinse to the wash cycle.

• **Easy ironing**

Through reduced agitation and controlled cooling of the wash water, this program limits wrinkles in the laundry and makes ironing easier.

• **Drying**

This program lets you run a drying cycle immediately after your wash cycle. This option always uses **HIGH drying temperature**. The program will stop automatically when the appliance estimates the laundry to be dry. Therefore you do not need to program the drying duration



Important :

Before switching your machine on, check that the electrical power cord is connected and the water valve is open. Ensure that the drum doors and the machine lid are properly closed.

In the "End of cycle" phase, when "StOP" is displayed, any action on one of the control elements (selector or buttons) lets you return to "Programming" mode.

For safety reasons, at the end of a cycle, we recommend disconnecting the power cord and shutting off the water supply valve.

• PROGRAM FOR COMPARATIVE AND STANDARDISED TESTS

- **Wash :**

Cotton - 60°C - 6 kg - No option - Max spin

- **Dry :**

Cotton - High drying - 4 kg

- **Properties :**

230V - 50Hz - 10A - 2200W.

For the results indicated on the energy label, the tests are conducted in accordance with European Directive 96/60/CE.

• OTHER FUNCTIONS

• Active memorisation

Your washing machine memorises your washing habits. For each new program it records the temperature, speed and the options that you most frequently use and proposes them as soon as you switch on.



Important :



When starting your appliance, it proposes the manufacturer's settings, but after a few cycles it will take into account your own settings.

• Draining

This function is for very delicate laundry and lets you eliminate spinning and go directly to the emptying phase.

• Full tank stop

This function lets you remove laundry from your machine before the spin phase or lets you defer this phase, and your laundry remains in the water to prevent it from creasing.

NB : When the machine is at full tank stop, the "Rinse / Spin"  cycle  sequence light and the **Remaining time** light flash alternately.

The display  shows "00:00".





Then :

– either you want to empty before spinning.



In this case, choose a spin speed suited to the type of laundry, using the "Spin" button .



Press the "Start/Pause" button  . The program will end automatically.

– or you want to empty only.

In this case, using the "Spin" button , choose the "Drain" function (spin speed "110").

Press the "Start/Pause" button  . The program will end automatically.

• Delayed start

You can delay the start of your program by 1 to 24 hours to take advantage of preferred energy rates or to end the cycle at the time desired.

To do this, select the required duration by pressing successively on the "Delay Start" (+) or (-)  buttons until you reach the duration required.

NB : The time remaining before the start of the cycle is counted in hours up to 1 hour, then in minutes from 59 to 1 minute.



Information :

During the entire wait period, four little segments light up one after the other.

At the end of the wait period, the program starts and the machine counts the time remaining before the end of the cycle.

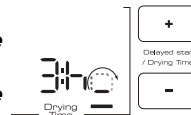

• OTHER FUNCTIONS (continued)

• Remaining Time Display

– During programming, the display ③ tells you the estimated duration of the program for a standard load (*).

(*) The time indicated by the machine at the start of the program may vary during the cycle:

- After estimating the load contained in the drum.
- If you change the washing temperature (even during the spin), if you add or remove options, the time will be recalculated and updated on the display.

– During the cycle, the display ③ shows you the estimated time remaining until the end of the cycle at all times.

– If power is disconnected during the wash phase, when power returns the time displayed may be less than the actual remaining time. This time will be adjusted at the start of the rinse phase.

• AUTOMATIC SAFETY FEATURES

• Lid opening safety

- As soon as the wash cycle has begun, your machine lid locks.
- As soon as the cycle ends or when the machine is at full tank stop, the lid unlocks.
- If you have programmed a "Delayed start", the lid is not locked during the wait period preceding the start of the cycle.
- If you want to open the lid during the cycle, press briefly on the "Start/Pause" button  and wait at least 1 to 2 minutes so that the lid safety feature unlocks.



Important :

Depending on the moment during the cycle when you wish to open the lid, this period may be longer since a cooling period is required.

Indeed, during the cycle, to prevent the lid from unlocking, the temperature inside the machine must not exceed a certain threshold, to prevent serious burns.

• Anti-foam safety

Your washing machine can detect excessive production of foam during the spin. In this case, the spin stops and the machine is emptied. The cycle then resumes, adjusting the spin speeds and possibly adding an extra rinse.

• Water safety

During operation, the water level is constantly checked to prevent any overflow.

• Spin safety

Your washing machine has a safety feature that can limit spinning if it detects that the load is poorly distributed.

In this case, your laundry may be insufficiently spun. Spread out your laundry evenly in the drum and program a new spin.

• **Cleaning the detergent dispenser**

Clean the detergent dispenser regularly.

To do this:

- Push the button forwards and **pull the dispenser upwards** (Fig. 18).
- Hold the dispenser under the hot water tap to thoroughly clean the inside of the compartments and the water intake areas.
- For easier cleaning of the fabric softener compartment, it has a **removable siphon** (coloured part). Make sure you replace it correctly after cleaning.
- Then replace the entire detergent dispenser in its housing, making sure it is positioned correctly.

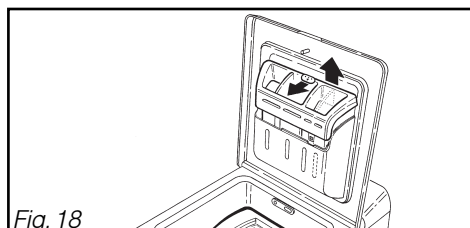

Fig. 18

• **Cleaning the pump filter**



Important :

If you do not clean the pump filter regularly, your machine's performance may be compromised.



Important :

First program emptying then disconnect the power supply.

To clean the pump filter :

- Remove the baseboard (Fig. 19).
- Place a flat recipient under the pump access.
- If your machine has a drain pipe, take it out by detaching the cap from the base (Fig. 20).
- Open the cap at the end of the pipe and let the water flow into the recipient (Fig. 20).
- Close the cap, making sure that it is pushed down and reattach it in the base.
- Unscrew the cap of the drainage pump filter (Fig. 21).
- Clean the filter.
- To replace it, insert it and point the small lug on the cylindrical surface upwards (Fig. 22).
- Screw the cap back on as far as it will go (Fig. 22).
- Replace the baseboard in its original position.



Important :

At the next wash, check that there is no leak during the filling phase.

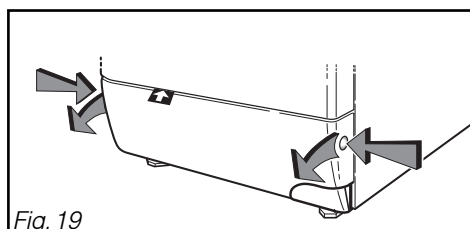

Fig. 19

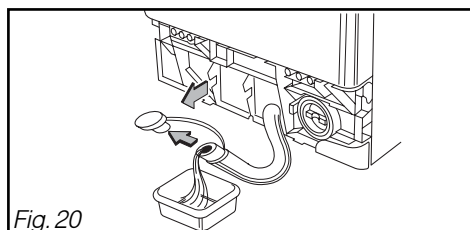

Fig. 20

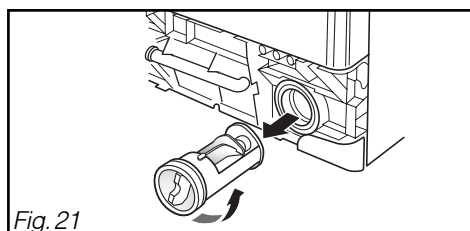

Fig. 21

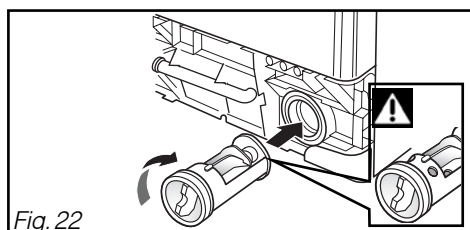

Fig. 22

• Access to the bottom of the tank

Removing the vane from the drum :

If an item of laundry falls between the drum and the vane:

- Close the drum after emptying it.
- Turn the drum until the vane attaches.
- Unscrew and remove the 2 screws **A** (TORX T20 recesses), the vane falls into the drum. Take the precaution of placing a towel to cushion the fall (*Fig. 23*).
- Turn the drum around and open it.
- Pick up the fallen part through the openings created by removal of the vane.
- To refit, insert the vane, from front to back, into its housing.
- Close the drum and turn it around.
- Hold the vane while you place the screws.

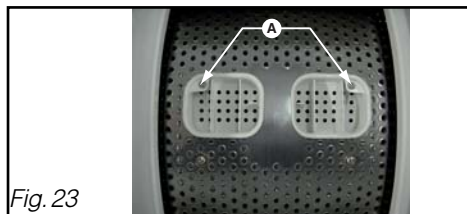

Fig. 23

• Cleaning the drying filter



Important :

The filter must be cleaned after every drying cycle.

The purpose of this filter is to catch the lint that forms during drying, so that it does not enter the air circulation system.

To clean the drying filter, proceed as follows:

- open the machine lid.
- the filter handle is on the right, near to the drum opening.
- remove the filter from its housing by pulling it towards you (*Fig. 24*).
- clean it without wetting it by pulling off the thin layer of lint covering it.
- return the filter to its housing, pushing it firmly into place.

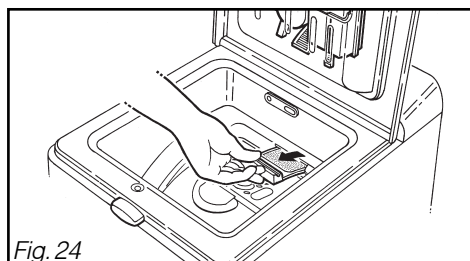

Fig. 24

• **Cleaning your appliance**

⚠ Important :
When cleaning the control panel, the drum access area and the body, use a sponge or a damp cloth and liquid soap only.

In all cases, **avoid the following (Fig. 25) :**

- Abrasive powders
- Metal or plastic sponges
- Alcohol-based products (alcohol, thinners, etc.)

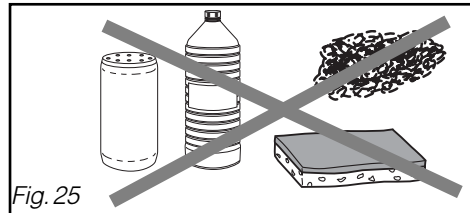

Fig. 25

• **MISCELLANEOUS MAINTENANCE**

• **Upkeep of internal parts**

To ensure better hygiene we recommend the following:

- leave the lid open for a while after washing.
- clean the plastic and rubber parts around the cavity access around once a month using a product with low bleach content. Rinse to eliminate all residue from this product.
- run a 90°C wash cycle at least once a month

• **Periodic checks**

We recommend that you check the condition of water supply and emptying hoses. If you observe the slightest cracking, do not hesitate to replace them with identical hoses available from the manufacturer or its After-Sales Service.

• **Replacement of the water supply hose**

When changing it, ensure it is well tightened and that there is a seal at both ends.

• **Replacement of the power cord**

⚠ Important :
To ensure your safety, this must be carried out by the manufacturer's after-sales service team or a qualified professional.

• **Risk of freezing**

If there is a risk of freezing, disconnect the water supply hose and empty the water that may be left in the emptying hose, placing the hose as low as possible in a cup.

**Tip :**

Certain incidents may arise when using your washing machine; here are the points to be checked.

Problems :	Possible causes / Remedies :
The cycle does not start :	<ul style="list-style-type: none"> - you have not pressed the "Start" button. - the appliance is not connected to the power source: <ul style="list-style-type: none"> - check that the plug is plugged in. - check the circuit-breaker and the fuses - the water intake valve is closed (d01) - the machine lid is not properly closed (d07) - the pause function is activated
The sensitive buttons are inactive :	<ul style="list-style-type: none"> - the "Child Safety" feature is activated: deactivate it by pressing the appropriate buttons
The display is off :	<ul style="list-style-type: none"> - check that the plug is plugged in. - check whether the circuit-breaker is activated - your machine is in "Energy savings" mode (display goes off after 1hr without action)
Strong vibrations during spinning :	<ul style="list-style-type: none"> - your machine is not properly unpacked: check that all the struts used for transport have been removed - the floor is not horizontal - your machine is not steady on all 4 feet: adjust the feet
A puddle of water forms around the machine :	<p> Caution : First remove the plug or cut off the relevant fuse and close the water intake valve.</p> <p>During operation of the appliance, the constant level check prevents water from overflowing. If water comes out of the machine in spite of this, it is possible that :</p> <ul style="list-style-type: none"> - the emptying cross-piece is incorrectly positioned in the discharge pipe. - the connections between the water supply hose and valve and the machine are not tight: check the presence of seals as well as tightening of connections - NB : excess foam may have caused overflow: in this case (slight leak), try to re-program a supervised cycle with a smaller amount of detergent. If the leak reoccurs, contact the After-Sales Service

**Important :**

Generally speaking, and regardless of the anomaly observed, the machine should be stopped, the power cord disconnected and the water intake valve closed.

Problems :	Possible causes / Remedies :
The machine does not empty :	<ul style="list-style-type: none"> - you have programmed "Full tank stop." - the drainage pump or filter are blocked: clean these parts - the discharge pipe is bent or flattened.
The load is not spun or insufficiently spun :	<ul style="list-style-type: none"> - you have selected a program without spin, for example "Draining". - The spin safety feature has detected poor distribution of the load in the drum: unpile the laundry and program another spin phase
The lid does not open :	<ul style="list-style-type: none"> - the program is not yet finished: the lid remains locked for the duration of the program, and for as long as the temperature remains too high (this may take a few minutes)
The drying cycle does not start :	<ul style="list-style-type: none"> - you have not selected a drying time - the estimated load is too large to combine automatically with drying (a flashing number 4 is displayed)
The laundry is not as dry as you wish it to be :	<ul style="list-style-type: none"> - the drying program chosen is not suitable for the type of laundry in the machine (Pay attention to the information given on the clothing labels) - the drying time selected is not suitable: increase or reduce the drying time according to the degree of drying required - the load of dried laundry is larger than the maximum load permitted (see Determination of the laundry load in the "SORTING THE LAUNDRY" chapter and the maximum loads permitted in the program table) - the laundry to be dried has not been spun sufficiently - with a washing program with subsequent drying: the load is not properly spread out. Automatic detection of the end of drying has stopped the drying cycle prematurely.
You want to run a wash only, but a drying cycle follows automatically :	<ul style="list-style-type: none"> - you have selected the "Drying" option

• INCIDENTS THAT YOU CAN FIX YOURSELF

Your appliance detects certain operating incidents itself and informs you via specific messages on the display. Below we explain how you can very easily fix these incidents yourself:

Messages	Causes / Remedies
d01	Filling fault. Check that the water intake valve is open, then press the "Start" button to restart the cycle.
d02	Emptying fault Clean the pump filter (refer to the chapter on "EVERYDAY MAINTENANCE: Cleaning the filter"), then press the "Start" button again to restart the cycle.
d07	Cover locking fault. Check the lid is closed then press the "Start" button again to restart the cycle.
4	Detection of a load that is too large to run subsequent drying. Reduce the load and restart the drying.

 **Important :**
If you have not been able to fix one of the above incidents yourself, call the repair engineer and relay the message displayed (d01, d02, etc.) to make the repair easier.

 **Tip :**
If you have experienced an operating problem which does not match the cases mentioned above, please proceed as follows before calling a repair engineer:
– turn the program selector to "OFF" position and turn off the power supply for at least 10 seconds.
– put the plug back in and start another wash cycle
If the problem continues, call your repair engineer.

 **Important :**
Do not start another wash cycle if the drum remains blocked, if you see water around your machine or if you can smell burning.

• INTERVENTIONS

Any repairs that are made to your appliance must be handled by a qualified professional authorised to work on the brand. When you call, mention your appliance's complete reference (model, type, serial number). This information appears on the manufacturer's rating plate (Fig. 26).

ORIGINAL PARTS

During any maintenance work, ask that only **certified original replacement parts be used.**

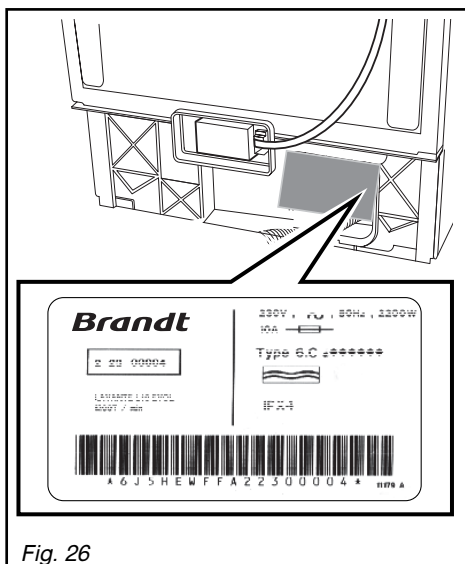

Fig. 26

EN After Sales Service :

Any maintenance on your equipment should be undertaken by:
 - either your dealer,
 - or another qualified mechanic who is an authorized agent for the brand appliances.

When making an appointment, state the full reference of your equipment (model, type and serial number). This information appears on the manufacturer's nameplate attached to your equipment.

FR Service après vente :

Les éventuelles interventions sur votre appareil doivent être effectuées :

- soit par votre revendeur,
- soit par un autre professionnel qualifié dépositaire de la marque.

Lors de votre appel, mentionnez la référence complète de votre appareil (modèle, type et numéro de série). Ces renseignements figurent sur la plaque signalétique fixée sur votre appareil.

DE Kundendienst :

Eingriffe an Ihrem Gerät dürfen nur:

- von Ihrem Händler oder
- von einem sonstigen Fachmann und Vertragshändler der Marke durchgeführt werden.

Geben Sie bei der Meldung einer Störung die vollständige Typenbezeichnung Ihres Gerätes an (Modell, Typ, Seriennummer). Diese Angaben finden Sie auf einem an Ihrem Gerät angebrachten Schild.

ES Servicio postventa :

Las intervenciones que requiera la máquina deberán ser efectuadas:

- por el revendedor,
 - o por cualquier profesional cualificado depositario de la marca.
- Al llamar, mencione la referencia completa de la máquina (modelo, tipo y número de serie). Estos datos figuran en la placa de identificación situada en la máquina.

PT Serviços autorizados :

Qualquer intervenção no seu aparelho deve ser realizada:

- quer pelo seu revendedor,
 - quer por outro profissional qualificado autorizado pela marca.
- Ao chamá los, indique a referência completa do seu aparelho (modelo, tipo e número de série). Estas informações figuram na placa de identificação fixada no aparelho.

DA Kundeservice :

Eventuel vedligeholdelse af apparatet skal foretages:

- enten af Deres forhandler,
- eller af en kvalificeret fagmand, som er anerkendt til dette mærke.

Når De ringer op, skal De angive apparatets fulde reference (model, type, serienummer). Disse oplysninger står på typeskiltet, der sidder på apparatet.

NL Serviceafdeling :

De eventuele ingrepen in de machine moeten worden uitgevoerd :

- of door uw vakhandelaar,
 - of door een andere gekwalificeerd technicus van dit merk.
- Tijdens het telefoneren, dient u de complete referentie op te geven van uw machine (model, type, serienummer). Deze informatie staat op het typeplaatje op de machine.

PL Usługi serwisowe :

Wszelkie czynności serwisowe wykonywane na urządzeniu muszą być wykonane przez:

- sprzedawcę,
- wyspecjalizowany zakład naprawczy posiadający atest producenta.

Aby przyspieszyć i ułatwić obsługę prosimy o podanie dokładnych danych dotyczących urządzenia (model, typ, numer seryjny). Wszystkie te dane znajdują się na tabliczce znamionowej umieszczonej na urządzeniu.

CS Záruční servis :

Případné opravy na přístroji může provádět pouze :

- váš prodejce
 - nebo záruční opravna, která má smlouvu s výrobcem
- Při telefonickém styku uvádějte úplně označení vašeho přístroje (model, typ a výrobní číslo). Tyto údaje jsou uvedeny na výrobním štítku přístroje.

RU Сервисное обслуживание :

При необходимости ремонта Вашей машины, он должен производиться:

- либо тем, кто ее продал Вам;
- либо специалистом, имеющим квалификацию по ремонту данной модели.

При обращении в службу ремонта укажите все данные Вашей машины (модель, тип и серийный номер). Эти данные указаны на идентификационной табличке, закрепленной на устройстве.

EL Τεχνική υποστήριξη :

Οι ενδεχόμενες επεμβάσεις πάνω στη συσκευή σας θα πρέπει να διενεργούνται:

- είτε από τον προμηθευτή σας,
- είτε από το κατά τόπους εξουσιοδοτημένο σέρβις.

Σε περίπτωση που τηλεφωνήσετε, θα πρέπει να αναφέρετε όλα τα στοιχεία της συσκευής σας (μοντέλο, τύπο και αριθμό σειράς). Τα στοιχεία αυτά αναγράφονται στην ετικέτα των χαρακτηριστικών του κατασκευαστή που βρίσκεται πάνω στη συσκευή.

WTD 6284K - WTD 6384K