



INSTRUCTION MANUAL

MF/HF MARINE TRANSCEIVER
IC-M802



FOREWORD

Thank you for purchasing this Icom product. The IC-M802 MF/HF MARINE TRANSCEIVER is designed and built with Icom's superior technology and craftsmanship. With proper care, this product should provide you with years of trouble-free operation.

We want to take a couple of moments of your time to thank you for making the IC-M802 your radio of choice, and hope you agree with Icom's philosophy of "technology first." Many hours of research and development went into the design of your IC-M802.

◇ FEATURES

- *Standard 4×8" remote controller*
- *Built-in DSC meets ITU Class E requirement*
- *E-mail function available*
- *PC connection capability for remote control*

PRECAUTIONS

⚠ **WARNING HIGH VOLTAGE! NEVER** attach an antenna to antenna connectors during transmission. This may result in an electrical shock or burn.

⚠ **WARNING! NEVER** connect the transceiver to an AC outlet directly. This may pose a fire hazard or result in an electric shock.

⚠ **WARNING! NEVER** mount the transceiver main unit overhead. The weight of the unit is approximately 4.7 kg (10 lb 6 oz), but its apparent weight will increase several fold due to wave shocks or vibration. The unit must be mounted on a flat hard surface only.

⚠ **WARNING! NEVER** place the transceiver where normal operation of the ship or vehicle may be hindered or where it could cause bodily injury.

⚠ **WARNING! NEVER** let metal, wire or other objects touch any internal part or connectors on the rear panel of the transceiver. This may result in an electric shock.

CAUTION: NEVER expose the transceiver to rain, snow or any liquids.

CAUTION: NEVER connect a power source of more than 15.64 V DC, such as a 24 V battery. This connection could cause a fire or ruin the transceiver.

DO NOT place the transceiver in excessively dusty environments or in direct sunlight.

IMPORTANT

READ THIS INSTRUCTION MANUAL CAREFULLY before attempting to operate the transceiver.

SAVE THIS INSTRUCTION MANUAL. This manual contains important safety and operating instructions for the IC-M802.

EXPLICIT DEFINITIONS

WORD	DEFINITION
⚠ WARNING!	Personal injury, fire hazard or electric shock may occur.
CAUTION	Equipment damage may occur.
NOTE	If disregarded, inconvenience only. No risk or personal injury, fire or electric shock.

DO NOT place the transceiver against walls or putting anything on top of the transceiver. This will obstruct heat dissipation.

DO NOT use or place the transceiver in areas with temperatures below -20°C (-4°F) or above $+55^{\circ}\text{C}$ ($+131^{\circ}\text{F}$).

DO NOT use harsh solvents such as benzine or alcohol to clean the transceiver, as they will damage the transceiver's surfaces. If the transceiver becomes dusty or dirty, wipe it clean with a soft, dry cloth.

BE CAREFUL! The heatsink will become hot when operating the transceiver continuously for long periods.

During maritime mobile operation, **KEEP** the transceiver and microphone **as far away** as possible (at least 1 m; 3 ft) from the magnetic navigation **compass** to prevent erroneous indications.

Use Icom microphones only (supplied). Other manufacturer's microphones have different pin assignments, and connection to the IC-M802 may damage the transceiver.

Place the unit in a secure place to avoid inadvertent use by children.

Icom, Icom Inc. and the Icom logo are registered trademarks of Icom Incorporated (Japan) in Japan, the United States, the United Kingdom, Germany, France, Spain, Russia and/or other countries.

IN CASE OF EMERGENCY

When your ship requires assistance, contact other ships and the Coast Guard by sending a distress call using digital selective calling on an emergency frequency.

When immediate help is needed

- ① Hold down [DISTRESS] for 5 seconds until the short beeps become one long beep, to send the distress call.
- ② After the appropriate traffic frequency is automatically selected (after an acknowledgement call is received), hold down the PTT switch on the microphone and send the following information.
 1. "MAY DAY, MAY DAY, MAY DAY."
 2. "THIS IS " (name of ship)
 3. "LOCATED AT . . . " (ship's position)
 4. Give the reason for the distress call.
 5. Explain what assistance you need.
 6. Give additional information:
 - Ship type
 - Ship length
 - Ship color
 - Number of people on-board

When potential problems exist

- ① Push [DSC] to select DSC watch mode, if necessary.
- ② Push [MODE SET] to select DSC menu, rotate [CH] to select "All ships" then push [ENT].
- ③ Follow the guidance displayed on the LCD (bottom line), to set up the category, traffic frequency and calling frequency with [CH], [ENT] and keypad.
- ④ Hold down [CANCEL/CALL] for 1 second until the short beeps become one long beep.
- ⑤ After an acknowledgement call is received, transmit the appropriate information using voice.
 - DSC equipped ships may monitor your transmission.

TABLE OF CONTENTS

FOREWORD.....	i	■ MMSI code programming	15	■ Verifying self-ID	48
IMPORTANT	i	■ Position and time programming ...	16	■ Memory reading/deleting	48
EXPLICIT DEFINITIONS	i	7 CALL PROCEDURE	17–38	11 E-MAIL OPERATION	49
PRECAUTIONS	i	■ Distress call	17	■ General	49
IN CASE OF EMERGENCY	ii	■ Distress call to ships	21	■ Operation	49
TABLE OF CONTENTS	ii	■ Urgency call	24	12 SET MODE	50–54
QUICK REFERENCE	iii–vii	■ Safety call	28	■ Quick set mode	50
■ How to set a Channel/Group	iii	■ Routine call	32	■ Initial set mode.....	51
■ Audio output/squelch adjustment ...	iv	■ Geographical call.....	34	13 CONNECTION AND INSTALLATION	55–64
■ Basic voice transmission and reception	v	■ Group call	36	55–64
■ Receiving a DSC.....	vi	■ Position request call	37	■ Supplied accessories	55
■ Transmitting a distress call.....	vi	■ Test call	38	■ Front panel connections.....	55
1 OPERATING RULES AND GUIDELINES	1	8 WHEN RECEIVING A CALL ...	39–44	■ Rear panel connections	56
2 PANEL DESCRIPTION	2–7	■ To receive a DSC call	39	■ Ground connection	57
■ Front panel— Controller	2	■ Received information	40	■ Power source	57
■ Front panel— Main unit	4	■ Deleting a memory	40	■ Antenna.....	58
■ Rear panel— Main unit	5	■ Position request call	41	■ Mounting	59
■ Microphone (HM-135).....	5	■ Distress call	41	■ Using the optional MB-75	60
■ LCD screen	6	■ Distress relay call	42	■ Transceiver dimensions	61
3 SETTING A CHANNEL/FREQUENCY	8–9	■ Individual call	43	■ Fuse replacement	62
.....	8–9	■ Group call	44	■ Connector information	63
■ Selecting a channel	8	■ Geographical area call	44	14 SPECIFICATIONS	65
■ Test call	8	■ Test call	44	15 OPTIONS	66
4 RECEIVE AND TRANSMIT	10–12	9 MEMORY OPERATION	45	16 TEMPLATE	67–70
.....	10–12	■ Memory description	45	67–70
■ Basic voice transmit and receive ...	10	■ Memory writing	45	■ Remote controller (RC-25).....	67
■ Functions for transmit	10	■ Memory reading/transmitting/deleting	45	■ Speaker (SP-24)	69
■ Functions for receive	11	10 DSC MENU OPERATION	46–48		
■ CW operation	13	46–48		
■ FSK operation	13	■ General	46		
5 CHANNEL NAME PROGRAMMING	14	■ ID input	46		
6 DSC PREPARATION	15–16	■ Frequency input	47		

QUICK REFERENCE

■ How to set a Channel/Group

The IC-M802 has up to 160 user-programmable, 249 ITU SSB duplex, 124 ITU SSB simplex and 662 ITU FSK duplex channels.

◇ Using the group and channel selectors

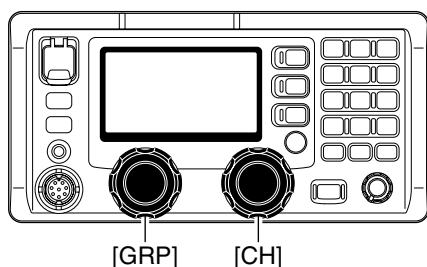

- ① Rotate [GRP] to select a desired group.
 - Available groups are shown in the list below.
 - During user-programmable channel group use, the channels change in 20-channel steps. See details on p. 8.
 - Example; When starting the user-programmable Ch. 1.
1↔21↔41...141↔401↔4-1↔601.....C2-1...1
- ② Rotate [CH] to select a desired channel.
 - Available channels are shown in the list below.
 - Pushing [▲]/[▼] on the microphone also selects a channel.

◇ Using the keypad

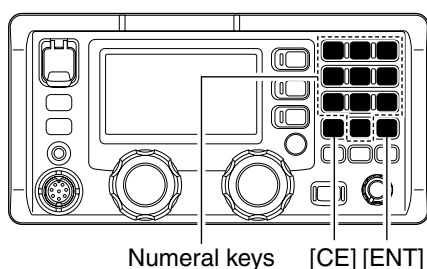

• When selecting an user-programmable channel

- ➔ Push the appropriate numeral keys to set the 1, 2 or 3-digit channel number, then push [ENT].
 - Pushing [CE] clears input digits and retrieves the channel.

Example; When selecting Ch. 1.

Push [1 NB] then push [ENT].

Example; When selecting Ch. 35.

Push [3 SCAN], [5 AGC^x] then push [ENT].

Example; When selecting Ch. 128.

Push [1 NB], [2 SQL], [8 Mid] then push [ENT].

• When selecting an ITU duplex channel

- ➔ Push the appropriate numeral keys to set the 3, 4 or 5-digit channel number, then push [ENT].
 - Pushing [CE] clears input digits and retrieves the previous channel.

Example; When selecting Ch. 401.

Push [4 SP^x], [0 DIM], [1 NB] then push [ENT].

Example; When selecting Ch. 2505.

Push [2 SQL], [5 AGC^x], [0 DIM], [5 AGC^x] then push [ENT].

• When selecting an ITU simplex channel

- ➔ Push the appropriate numeral keys to set the 5 or 6-digit channel number, then push [ENT].
 - Push [0 DIM] 3 times to enter “-” (dash).^{*}
 - Pushing [CE] clears input digits and retrieves the previous channel.

Example; When selecting Ch. 4-1.

Push [4 SP^x], [0 DIM], [0 DIM], [0 DIM], [1 NB] then push [ENT].

- After pushing [0 DIM] 3 times, “-” appears.

Example; When selecting Ch. 25-2.

Push [2 SQL], [5 AGC^x], [0 DIM], [0 DIM], [0 DIM], [2 SQL] then push [ENT].

- After pushing [0 DIM] 3 times, “-” appears.

• Available channel groups and channels

Channel No.	Description	Channel No.	Description	Channel No.	Description
1 to 160	User Ch.* ¹	1201 to 1241	12 MHz ITU duplex Ch.	22-1 to 22-9	22 MHz ITU simplex Ch.
401 to 427	4 MHz ITU duplex Ch.	12-1 to 12-9	12 MHz ITU simplex Ch.	2501 to 2510	25 MHz ITU duplex Ch.
4-1 to 4-9	4 MHz ITU simplex Ch.	1601 to 1656	16 MHz ITU duplex Ch.	25-1 to 25-9	25 MHz ITU simplex Ch.
601 to 608	6 MHz ITU duplex Ch.	16-1 to 16-9	16 MHz ITU simplex Ch.	C1-1 to C1-21	C1 channels
6-1 to 6-9	6 MHz ITU simplex Ch.	1801 to 1815	18 MHz ITU duplex Ch.	C2-1 to C2-31	C2 channels
801 to 832	8 MHz ITU duplex Ch.	18-1 to 18-9	18 MHz ITU simplex Ch.	4001 to 25040	ITU FSK duplex Ch.* ²
8-1 to 8-9	8 MHz ITU simplex Ch.	2201 to 2253	22 MHz ITU duplex Ch.		

*[GRP] changes in 20 channel steps. *²SITOR use— no group separation.

Audio output/squelch adjustment

Audio output level

Rotate [VOL] to adjust audio output level.

NOTE: Make sure that no “ESP” and “SQL” indicators are displayed during audio level adjustment, otherwise, audio may not be output.

If either or both indicators are displayed, perform the following operations;

- When “ESP” is displayed, push [F] then [4 SP*].
- When “SQL” is displayed, push [F] then [2 SQL].

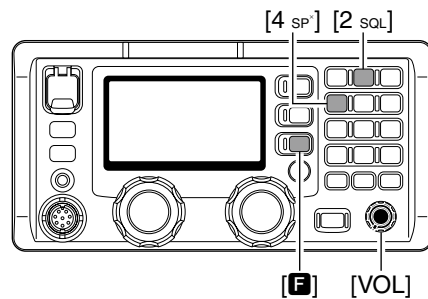

Squelch function

Push [F] then [2 SQL] to turn the squelch function ON or OFF.

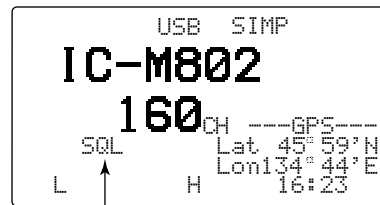
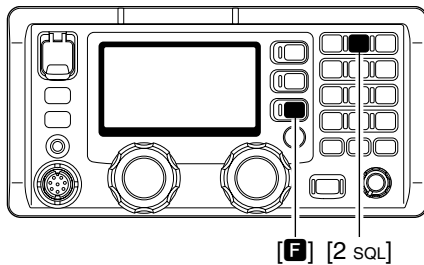

“SQL” appears when the squelch function is ON.

Squelch level adjustment

- ① Push [F] then [2 SQL] to turn ON the squelch function.
 - First select the desired frequency or channel.
- ② Push [F] then [MODE SET] to enter the quick set mode.

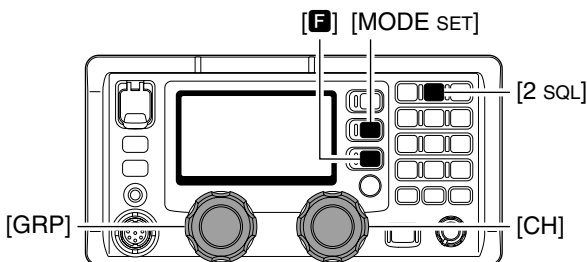

- ③ Rotate [GRP] to select the “S-SQL LEVEL” item.
- ④ Rotate [CH] to adjust the squelch level.
 - Adjust the level to between 1 and 100.

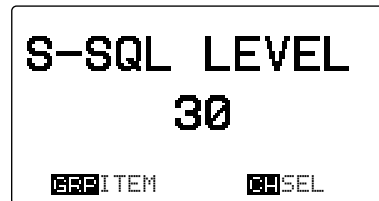

- ⑤ Push [MODE SET] to exit the quick set mode.

Voice squelch function

The voice squelch function detects voice components in the received signal and opens the squelch only when voice components are included in the signal.

- ① While holding down [MODE SET], turn ON the power to enter the initial set mode.

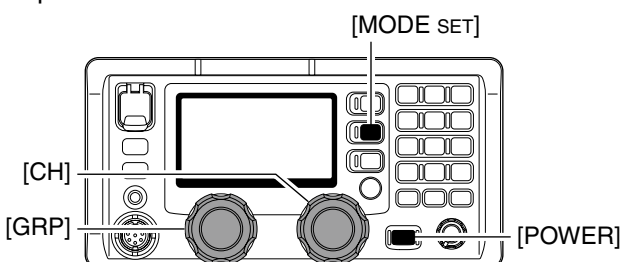

- ② Rotate [GRP] to select the “VOICE SQL” item.
- ③ Rotate [CH] to turn the voice squelch function ON or OFF

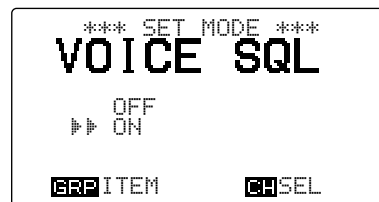

- ④ Turn the power OFF then ON again to exit the initial set mode.

Basic voice transmission and reception

◆ Receiving a signal

- ① Select the desired channel using [GRP] and [CH], or the keypad.
 - Turn the squelch function ON and OFF, or adjust the squelch level as desired.
- ② When a signal is received, the “RX” indicator appears and audio is heard from the connected speaker.
 - Rotating [VOL] to adjust the audio output level at this step is recommended.
 - The S-meter shows the received signal strength.
- ③ Use the following functions, if desired:
 - **Noise blanker**
Push [F] then [1 NB] to turn the noise blanker ON or OFF.
 - “NB” appears when the noise blanker is activated.
 - See page 50 for the noise blanker level adjustment.
 - **AGC (Automatic Gain Control) OFF function**
Push [F] then [5 AGC*] to turn the AGC OFF function ON or OFF.
 - “AGC” appears when the AGC-OFF function is activated (deactivating the AGC).

• RF gain level

- Push [F], [6 RF-G] to enter the RF gain adjustment mode, then rotate [CH] to adjust the gain.
- Set the gain to between 0 (low sensitivity) and 9 (maximum sensitivity).
 - Push [MODE SET] to exit the adjustment mode.

• Clarity

- Push [F], [RX CLAR] to switch the clarity function ON or OFF, then rotate [CH] for fine tuning.

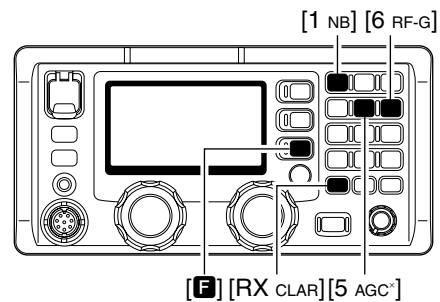

◆ Transmitting in voice

- ① Select the desired channel using [GRP] and [CH], or the keypad.
- ② Push [F], then hold down [TX TXF] to temporarily monitor the transmit frequency of the selected channel.
 - The transmit frequency is displayed and “TX” blinks.
 - If the channel is busy, wait until it becomes clear, or change to another channel.

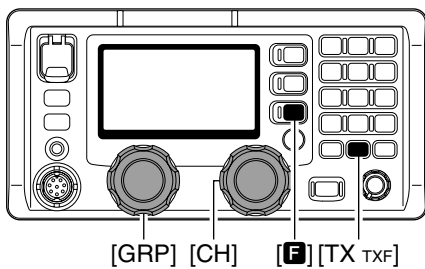

- ③ Push [F] then either [7 Lo], [8 Mid] or [9 Hi] to select low, middle or high output power, respectively.

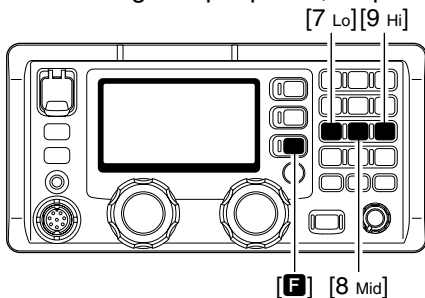

- ④ When the optional AT-140 is connected, push [TUNE THRU] to start tuning.
 - “TUNE” appears when the antenna is tuned.
 - “TUNE” blinks when a tuning error has occurred.
 - Automatic tuning can also be done.

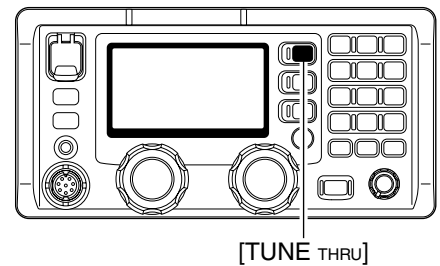

- ⑤ Hold down [PTT] on the microphone to transmit.
 - “TX” appears.
 - If “SUR” appears during transmit, check your antenna system.
- ⑥ Speak into the microphone at your normal voice level.
- ⑦ Release [PTT] to return to receive.
 - “TX” disappears.

■ Receiving a DSC

- ➔ To receive a DSC call, such as an individual, group or all ships call on the desired frequencies, push [DSC] to enter the DSC watch mode.
 - Monitoring the frequencies, 2187.5, 4207.5, 6312.0, 8414.5, 12577.0 and 16804.5 kHz, for distress, urgency, etc., no operation is necessary with the transceiver. These frequencies are monitored at all times.

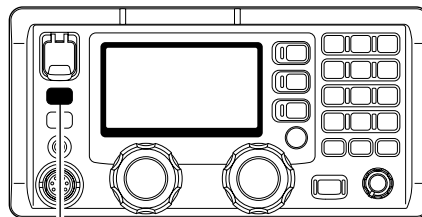

[DSC]

■ Transmitting a distress call

◇ Simple distress call

- ➔ Lift up the distress switch cover, then hold down [DISTRESS] for 5 seconds.
 - After 5 seconds, a distress call is sent.

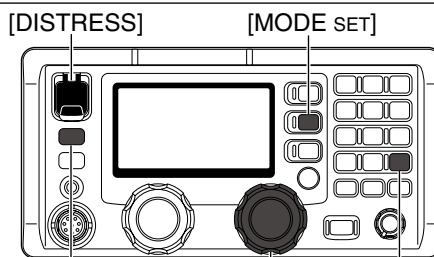

[DISTRESS]

[MODE SET]

[DSC]

[CH]

[ENT]

◆ Regular distress call

① Push [DSC] to enter DSC watch mode.

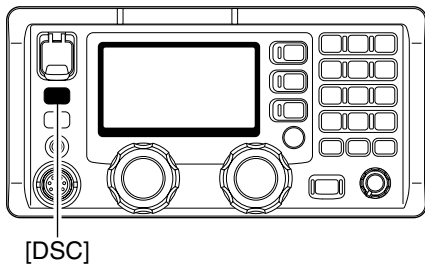

② Push [MODE SET] to enter DSC menu.

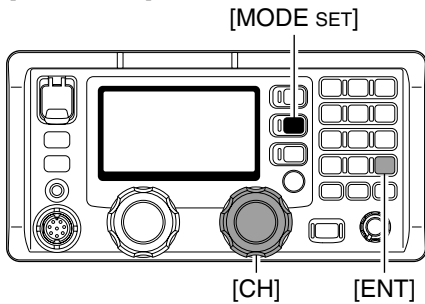

③ Rotate [CH] to select "Distress" then push [ENT].



④ Rotate [CH] to select the desired situation, then push [ENT].

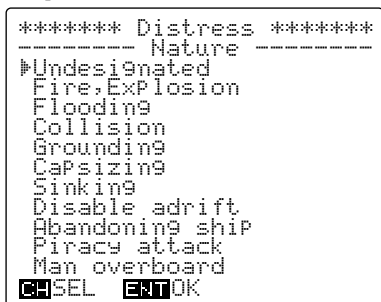

⑤ Verify your position and the UTC time, then push [ENT].

- When no position data from a GPS receiver is sent, your position and UTC time should be input in this step.

- Use the keypad and [CH] when changing your position or the time.
- Move the cursor with [CH] rotation.
- [3 SCAN], [6 RF-G], [7 Lo] and [9 Hi] is used for the 'East,' 'North,' 'South' and 'West' selection.

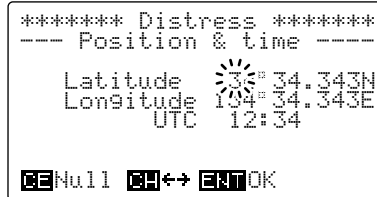

⑥ Rotate [CH] to select a DSC calling frequency, then push [ENT].

- After pushing [ENT], return to the DSC menu, as shown in step ③.



⑦ Lift up the distress switch cover, then hold down [DISTRESS] for 5 seconds.

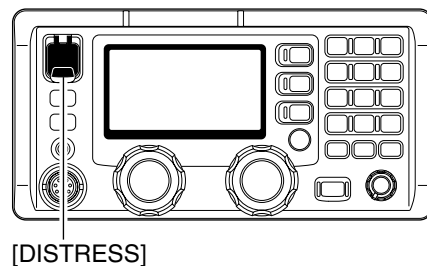

Before transmitting, monitor the channel you wish to use to avoid interrupting transmissions already in progress.

• CALL PROCEDURE

Calls must be properly identified and the time limit must be respected.

- ① Give your call sign each time you call another ship or coast guard station. If you have no call sign, identify the station by giving your ship name and the name of the licensee.
- ② Give your call sign at the end of each transmission that lasts more than 3 minutes.
- ③ You must break and give your call sign at least once every 15 minutes during long ship-to-shore calls.
- ④ Keep your unanswered calls short, less than 30 seconds. Do not repeat a call for 2 minutes.
- ⑤ Unnecessary transmissions are not allowed.

• PRIORITIES

- ① Read all rules and regulations pertaining to priorities and keep an up-to-date copy handy. Safety and distress calls take priority over all others.
- ② False or fraudulent distress signals are prohibited and punishable by law.

• PRIVACY

- ① Information overheard but not intended for you, cannot lawfully be used in any way.
- ② Indecent or profane language is prohibited.

• LOGS

- ① All distress, emergency and safety calls must be recorded in complete details. Log data activity is usually recorded in 24 hour time. Universal Time Coordinated (UTC) is frequently used.
- ② Adjustments, repairs, channel frequency changes and authorized modifications affecting electrical operation of the equipment must be kept in the maintenance log; entries must be signed by the authorized licensed technician performing or supervising the work.

• RADIO LICENSES

(1) SHIP STATION LICENSE

You must have a current radio station license before using the transceiver. It is unlawful to operate a ship station which is not licensed.

Inquire through your dealer or the appropriate government agency for a Ship-Radiotelephone license application. This government-issued license states the call sign which is your craft's identification for radio purposes.

(2) OPERATOR'S LICENSE

A Restricted Radiotelephone Operator Permit is the license most often held by small ship radio operators when a radio is not required for safety purposes.

The Restricted Radiotelephone Operator Permit must be posted or kept with the operator. Only a licensed radio operator may operate the transceiver.

However, non-licensed individuals may talk over a transceiver if a licensed operator starts, supervises, and ends the call and makes the necessary log entries.

Keep a copy of the current government rules and regulation handy.

■ Front panel— Controller

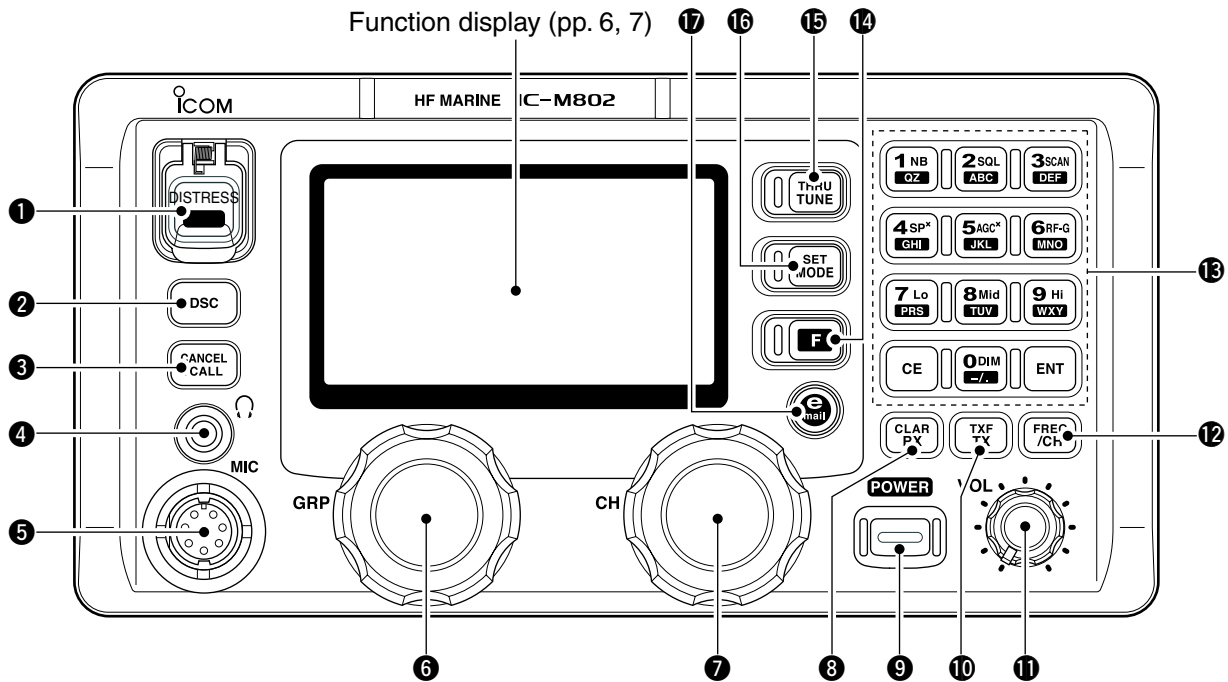

1 DISTRESS SWITCH [DISTRESS] (p. 17)

Hold down for 5 seconds (approximately) to make a distress call.

2 DSC SWITCH [DSC]

Switches between the DSC watch mode and the voice/e-mail communication mode when pushed.

3 CANCEL/CALL SWITCH [CANCEL/CALL]

- ➔ Cancels a distress or DSC repeat call. (p. 20)
- ➔ Hold down for 1 second to start calling after the DSC has been setup.

4 HEADPHONE JACK []

Accepts headphones.

- Output power: 5 mW with a 16 Ω load (stereo/monaural)

5 MICROPHONE CONNECTOR [MIC]

Accepts the supplied or optional microphone.

- See p. 65 for appropriate microphones.
- See p. 63 for microphone connector information.

6 GROUP SELECTOR [GRP]

- ➔ Selects groups in 20 channel steps and ITU marine channel groups. (p. 8)
- ➔ Selects items during the quick/initial set mode.

7 CHANNEL SELECTOR [CH]

- ➔ Selects an operating channel within the selected channel group, such as ITU channels. (p. 8)
 - User channels can be sequentially selected between 1 to 160 (maximum) regardless of the channel group.
- ➔ Changes the setting or value of the selected item in the quick/initial set mode.

8 RX/CLARITY SWITCH [RX CLAR]

- ➔ After pushing [F], turns the clarity function ON or OFF. (p. 12)
 - [CH] is used to adjust the clarity.
- ➔ In the DSC watch mode, opens the RX memory select screen. (p. 40)
 - [CH] is used for distress and other call selection.

9 POWER SWITCH [POWER]

- ➔ Push to turn ON the power.
- ➔ Hold down for 1 second to turn OFF the power.

10 TX/TRANSMIT FREQUENCY SWITCH [TX TXF]

- ➔ After pushing [F], displays the transmit frequency, and opens the squelch. Checks and monitors the transmit frequency while holding down. (p. 10)
- ➔ In the DSC watch mode, opens the TX memory select screen. (p. 45)
 - [CH] is used for memory selection.

11 VOLUME CONTROL [VOL]

Adjusts the audio output level.

- Audio does not come from the speaker when:
 - The speaker mute switch is turned ON.
 - The squelch function is turned ON and no signal is being received.
- In the DSC watch mode.

12 FREQUENCY/CHANNEL SWITCH [FREQ/CH]

- ➔ Selects display type: (p. 8)
- When "CH-FREQUENCY" is selected;
 - ➔ Toggles channel number and TX frequency.
- When "CH-NAME" is selected;
 - ➔ Toggles channel comment and number, and TX/RX frequencies.
- ➔ After pushing [F], enters the channel name programming mode, when the channel comment indication is set to ON. (p. 14)

13 KEYPAD

- 1 NB QZ** ➔ Inputs the number "1" for channel number input.
➔ Inputs "1," "Q," "Z," "q," "z" or space for channel comment input.
➔ After pushing [F], turns the noise blanker function ON or OFF. (p. 11)
- 2 SQL ABC** ➔ Inputs the number "2" for channel number input.
➔ Inputs "2," "A," "B," "C," "a," "b" or "c" for channel comment input.
➔ After pushing [F], turns the squelch function ON or OFF. (p. 11)
- 3 SCAN DEF** ➔ Inputs the number "3" for channel number input.
➔ Inputs "3," "D," "E," "F," "d," "e" or "f" for channel comment input.
➔ After pushing [F], starts and stops the scan function. (p. 9)
- 4 SP^x GHI** ➔ Inputs the number "4" for channel number input.
➔ Inputs "4," "G," "H," "I," "g," "h" or "i" for channel comment input.
➔ After pushing [F], turns the speaker output ON or OFF. (p. 10)
- 5 AGC^x JKL** ➔ Inputs the number "5" for channel number input.
➔ Inputs "5," "J," "K," "L," "j," "k" or "l" for channel comment input.
➔ After pushing [F], turns the AGC OFF function ON or OFF. (p. 11)
- 6 RF-G MNO** ➔ Inputs the number "6" for channel number input.
➔ Inputs "6," "M," "N," "O," "m," "n" or "o" for channel comment input.
➔ After pushing [F], enters the RF gain adjustment mode. (p. 11)
- 7 Lo PRS** ➔ Inputs the number "7" for channel number input.
➔ Inputs "7," "P," "R," "S," "p," "r" or "s" for channel comment input.
➔ After pushing [F], selects low transmit output power. (p. 10)

- 8 Mid TUV** ➔ Inputs the number "8" for channel number input.
➔ Inputs "8," "T," "U," "V," "t," "u" or "v" for channel comment input.
➔ After pushing [F], selects the mid transmit output power level. (p. 10)

- 9 Hi WXY** ➔ Inputs the number "9" for channel number input.
➔ Inputs "9," "W," "X," "Y," "w," "x" or "y" for channel comment input.
➔ After pushing [F], selects the high transmit output power level. (p. 10)

- 0 DIM -/** ➔ Inputs the number "0" for channel number input.
➔ Inputs "0" and symbols (— / * ; () * + < = > a) for channel comment input.
➔ After pushing [F], selects the LCD backlight brightness level.

- ENT** ➔ Fixes input of channel number and channel comment.
➔ When held down for 1 second, stores programmed frequency, operating mode and memory comment into a channel.

- CE** ➔ Clears entered digits and returns to the previous frequency, channel or channel names during setting.

14 FUNCTION SWITCH [F]

- ➔ After pushing, activates the secondary functions.
- "[F]" appears when a secondary function can be accessed.

15 TUNE/THROUGH SWITCH [TUNE THRU]

- ➔ Starts tuning when an optional antenna tuner is connected.
 - "TUNE" appears when tuned.
 - When the tuner cannot tune the antenna, the tuning circuit is automatically bypassed after 15 seconds.
- ➔ After pushing [F], bypasses the connected antenna tuner. (p. 12)
 - "THRU" appears instead of "TUNE".
 - This operation is for only the AT-140 and AH-3.

16 MODE/SET SWITCH [MODE SET]

- ➔ Push to select an operating mode.
 - J3E (USB), H3E (AM), LSB, J2B (AFSK), F1B (FSK), and A1A (CW) modes are selectable, depending on the radio version or regulations.
- ➔ After pushing [F], enters the quick set mode. (p. 50)
- ➔ Opens the DSC menu in the DSC watch mode.

17 E-MAIL SWITCH [e-mail] (p. 49)

- ➔ Switches between the e-mail operation mode and voice operation mode when pushed.

■ Front panel— Main unit

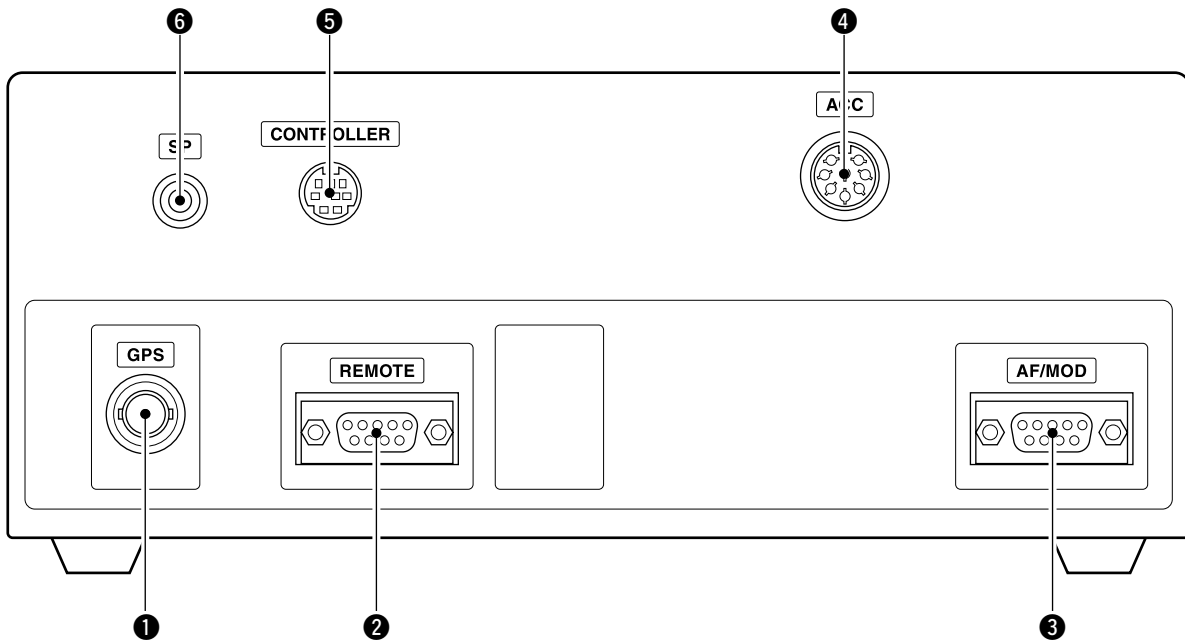

1 GPS CONNECTOR [GPS] (pp. 55, 64)

Input position and UTC data from a GPS receiver for DSC operation. (NMEA0183 ver. 3.01 format)

- An NMEA ver. 3.01 (sentence formatters: GGA) compatible GPS receiver is required. Ask your dealer about suitable GPS receivers.

2 REMOTE CONNECTOR [REMOTE] (pp. 55, 64)

Connects to a PC through an RS-232C cable (D-sub 9-pin) for remote control in the NMEA or RS-232C format.

3 MODEM CONNECTOR [AF/MOD] (pp. 55, 64)

Connects to an e-mail modem, NBDP (Narrow Band Direct Printing) or FAX system through an RS-232C cable (D-sub 9-pin).

4 ACCESSORY CONNECTOR [ACC]

(pp. 13, 63)

Connects a CW keyer or an FSK terminal unit.

5 CONTROLLER CONNECTOR [CONTROLLER]

(p. 53)

Connects the supplied remote controller.

6 SPEAKER JACK [SP] (p. 53)

Connects to an external speaker.

■ Rear panel— Main unit

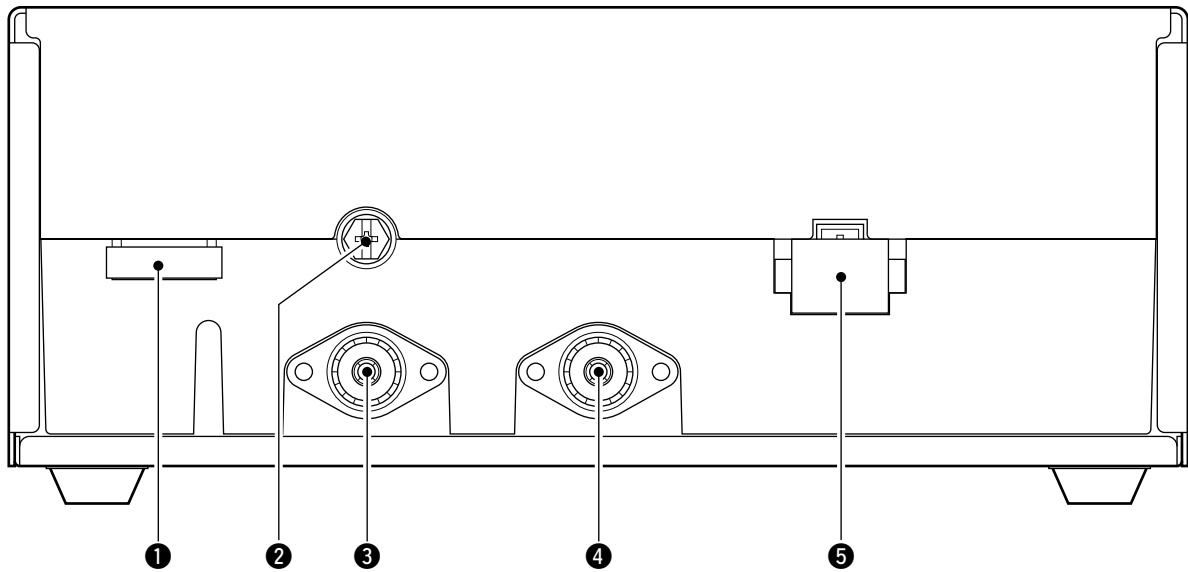

- 1 TUNER CONTROL SOCKET** (pp. 56, 58, 63)
 Connects a control cable to an optional antenna tuner.
 A female connector kit is supplied for external antenna tuner connection.
- 2 GROUND TERMINAL**
IMPORTANT! Connects to a ship's (or vehicle's) ground. See page 57 for details.
- 3 ANTENNA CONNECTOR 1** (pp. 56, 58)
 Connects a 50 Ω HF band antenna through a 50 Ω matched coaxial cable with a PL-259 plug, for both transmit and receive operation.

- 4 ANTENNA CONNECTOR 2** (pp. 56, 58)
 Connects a 50 Ω HF band antenna through a 50 Ω matched coaxial cable with a PL-259 plug for a DSC receiver.
IMPORTANT! An HF antenna must be connected to this antenna connector, otherwise no DSC call can be received.
- 5 DC POWER SOCKET** (pp. 56, 63)
 Connects 13.6 V DC through the supplied DC power cable.

■ Microphone (HM-135)

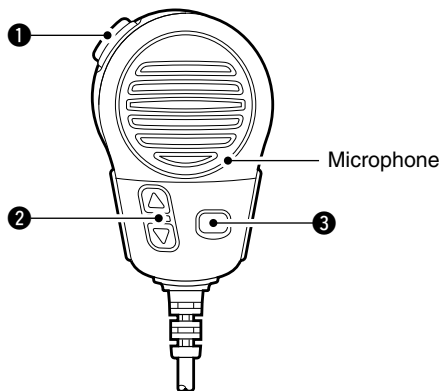

- 1 PTT SWITCH [PTT]**
 Hold down to transmit; release to receive.
- 2 UP/DOWN SWITCHES [▲]/[▼]**
 Push either switch to change the operating channel, frequency.
- 3 USER PROGRAMMABLE SWITCH [P]**
 Push to activate or deactivate a function, selected in the initial set mode (p. 53).

■ LCD screen

The IC-M802 has 3 display types; the channel name display, the frequency display and the DSC watch mode display. These indication types can be switched with a push of a button, depending on set mode's setting. See pages 8 and 52 for display type settings.

• Channel name indication

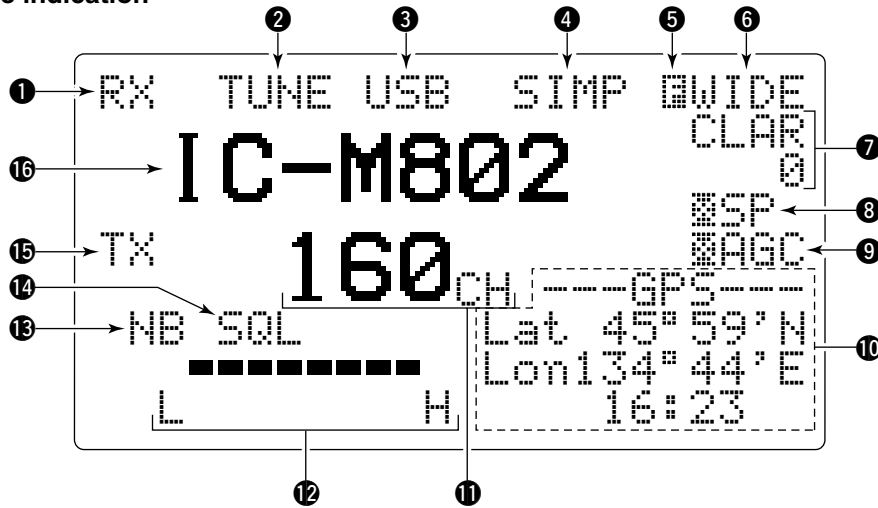

• Frequency indication

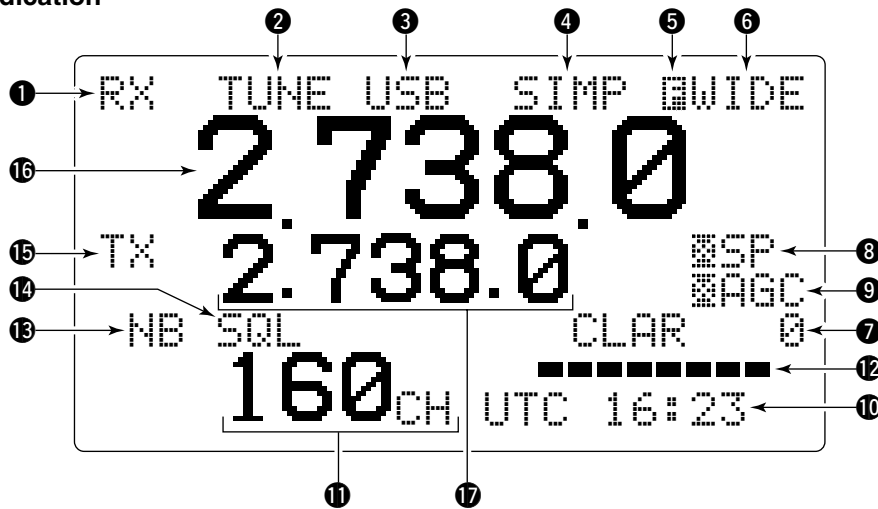

• DSC watch mode indication



1 RECEIVE INDICATOR

“RX” is displayed when signals are received or the squelch is open.

2 TUNE INDICATOR

“TUNE” blinks while tuning, if an optional external antenna tuner is connected. (p. 10)

- “TUNE” is displayed after tuning is completed with the AT-140, AT-130/E and AH-3.
- “THRU” is displayed when the Tuner Through function is activated.

(This function is usable only when using a AT-140 or AH-3.)

- “SWR” is displayed when the antenna SWR worsens during transmit, depending on the transmit output power. If it is displayed, check your antenna system.

3 OPERATING MODE INDICATOR

Displays the selected operating mode.

- “VZE” “USB” “HBE” “FM” “LSB” “VZE” “AFS” “FIB” “FSK” “AIA” or “CW” is displayed depending on operating mode and setting.

4 SIMPLEX/DUPLEX INDICATOR

“SMP” is displayed when a simplex channel is selected.

“DUP” is displayed when a duplex channel is selected.

5 FUNCTION INDICATOR

“F” is displayed when a secondary function can be accessed.

6 IF FILTER WIDTH INDICATOR

Displays the selected IF filter passband width in the e-mail operation mode.

7 CLARITY INDICATOR (p. 12)

“CLAR” is displayed when the clarity function is activated and shows the shifting frequency in “Hz.”

8 SPEAKER OFF INDICATOR

“SPO” is displayed when the speaker output is turned OFF.

9 AGC OFF INDICATOR (p. 11)

“SAGC” is displayed when the AGC OFF function is turned ON.

10 POSITION/UTC TIME INDICATOR (p. 16)

Displays position and/or UTC (or local) time. When a GPS receiver is connected to [GPS], the indication is automatically updated.

- When no GPS receiver is connected, the position and UTC time must be set manually.
- “GPS” is displayed when an NMEA0183 ver. 3.01 data is applied to [GPS], “MAN” appears when the position is manually set.
- “UTC” is displayed when the offset time has not been programmed. (No “UTC” indication when offset time is programmed and shows local time.)

11 CHANNEL NUMBER INDICATION

Displays the selected channel number.

12 S/RF INDICATOR

Displays the relative transmit output power levels during transmit and the receive signal strength during receive.

13 NOISE BLANKER INDICATOR (p. 11)

“NB” is displayed when the noise blanker function is ON.

14 SQUELCH INDICATOR (p. 11)

“SQL” is displayed when the squelch is ON.

15 TRANSMIT INDICATOR

- “TX” is displayed during transmit.
- “TX” blinks while monitoring a transmit frequency. (p. 10)

16 CHANNEL NAME/RECEIVE FREQUENCY READOUT

- Displays the programmed channel names.
- Displays the receive frequency when no channel name is programmed, when the frequency display is selected.
- In the DSC watch mode, displays “DSC WATCH.”

17 TRANSMIT FREQUENCY READOUT

Displays the transmit frequency.

18 OPERATING GUIDE INDICATION

During DSC watch mode operation, displays several types of control guidance, depending on the selected screen.

19 SCANNING FREQUENCY READOUT

In the DSC watch mode, displays the programmed scan frequency.

- Decimal points blink.

■ Selecting a channel

The transceiver has 160 user channels and ITU channels. However, the number of user channels can be optionally restricted.

◇ Display selection

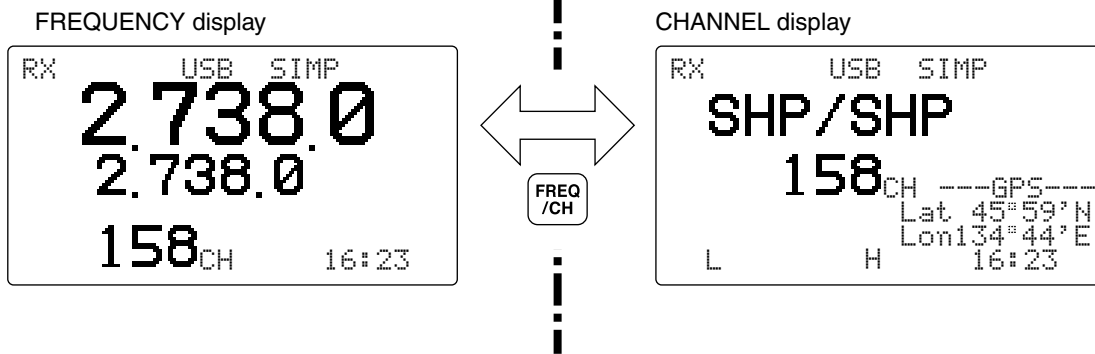

NOTE: The channel name (alphanumeric) may not appear when the frequency is displayed, depending on the initial set mode setting. (p. 52)

◇ Using the channel selector

The transceiver has two large controls for group selection and channel selection. The [GRP] changes channels in 20 channel increments and selects ITU channel groups; the [CH] selects each channel.

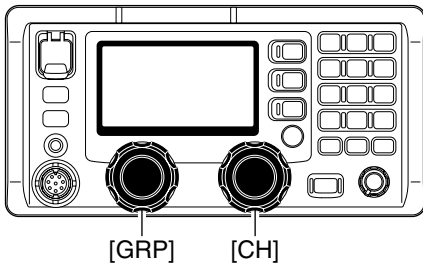

- ① Rotate [GRP] to select the desired channel group as shown to the right and below.
- ② Rotate [CH] to select the desired channel.

[EXAMPLE]: Selection with the [GRP]

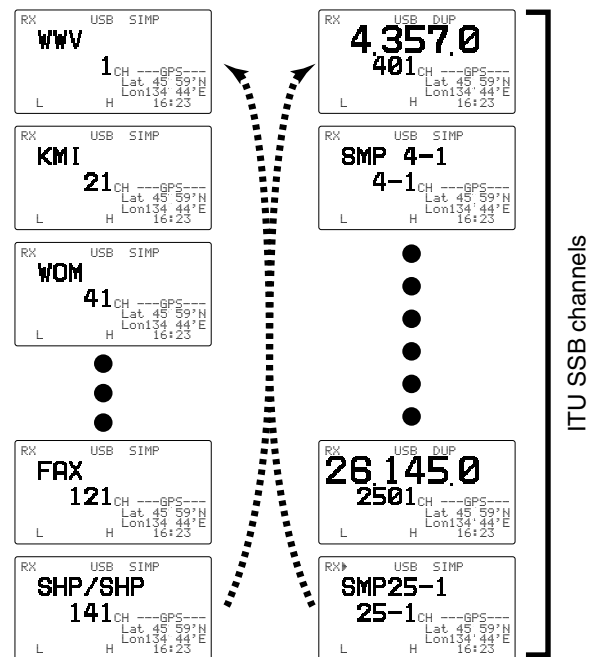

CHANNEL GROUPS

*1[GRP] changes in 20 channels steps. *2SITOR use— no group separation.

Channel No.	Description	Channel No.	Description	Channel No.	Description
1 to 160	User Ch.*1	1201 to 1241	12 MHz ITU duplex Ch.	22-1 to 22-9	22 MHz ITU simplex Ch.
401 to 427	4 MHz ITU duplex Ch.	12-1 to 12-9	12 MHz ITU simplex Ch.	2501 to 2510	25 MHz ITU duplex Ch.
4-1 to 4-9	4 MHz ITU simplex Ch.	1601 to 1656	16 MHz ITU duplex Ch.	25-1 to 25-9	25 MHz ITU simplex Ch.
601 to 608	6 MHz ITU duplex Ch.	16-1 to 16-9	16 MHz ITU simplex Ch.	C1-1 to C1-21	C1 channels
6-1 to 6-9	6 MHz ITU simplex Ch.	1801 to 1815	18 MHz ITU duplex Ch.	C2-1 to C2-31	C2 channels
801 to 832	8 MHz ITU duplex Ch.	18-1 to 18-9	18 MHz ITU simplex Ch.	4001 to 25040	ITU FSK duplex Ch.*2
8-1 to 8-9	8 MHz ITU simplex Ch.	2201 to 2253	22 MHz ITU duplex Ch.		

◇ Using the keypad

The keypad can be used to directly enter channels.

- ① Enter the desired channel number using the keypad.
 - Pushing [CE] clears the input digits and returns to the previous channel.
 - A user channel is selected when channel 1–160 is input (maximum number may be optionally restricted).
 - An ITU SSB channel is selected when channel numbers higher than 401 are input.
 - When selecting an ITU simplex channel, push [0 DIM] three times to input a “– (dash).” (e.g. When selecting channel 4-1: — push [4 SP^x], [0 DIM], [0 DIM], [0 DIM] then [1 NB].)
- ② Push [ENT] to set the channel.

[EXAMPLE]: Selecting channel 158

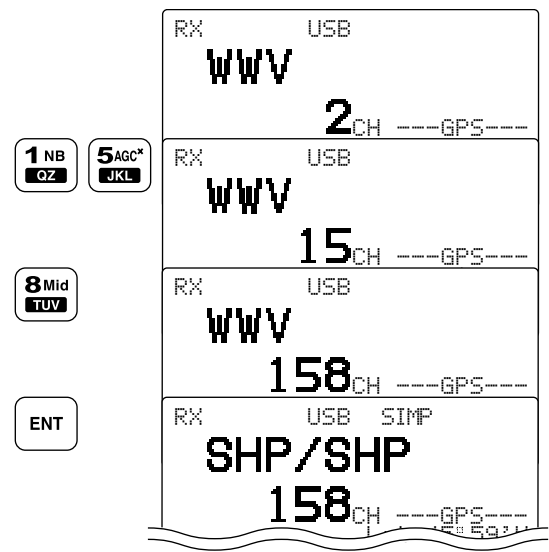

◇ Using scan function

The transceiver has 3 types of scan functions you can select to suit your needs.

Channel scan/Channel resume scan

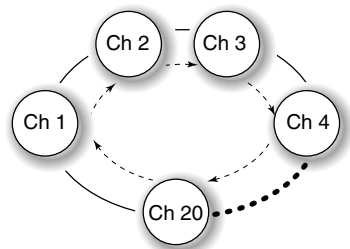

When resume is OFF:
The scan does not pause, even if a signal is received.

When resume ON:
The scan pauses for 10 seconds, then resumes, or resumes after 2 seconds from when the signal disappears.

Programmed scan

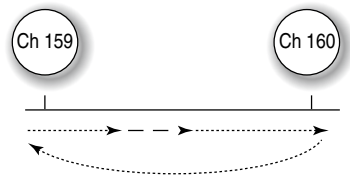

Scans the frequency range between the programmed frequencies on channels 159 and 160.
Scans fast when the squelch is closed and slowly when the squelch is open.

The channel scan and channel resume scan scan in groups of 20 channels from the lowest channel number in the group, such as Ch 1 to Ch 20, Ch 141 to Ch 160 (user channels), or all the channels in the ITU channel group.

The programmed scan scans frequencies in the frequency range between user channels 159 and 160. Scan type selection is made in initial set mode. See page 52 for details.

SCAN OPERATION

- ① Rotate [GRP] and [CH], or use the keypad to select your desired channel group.
 - This step is not necessary for a programmed scan.
- ② Push [F] then [2 SQL] to turn OFF the squelch function, if a programmed scan is selected.
- ③ Push [F] then [3 SCAN] to start the scan.
- ④ To stop the scan, repeat step ③ again.
 - [CH] rotation, or pushing some other switch, also stops the scan.

Basic voice transmit and receive

- ① First, check the following.
 - Microphone is connected.
 - “SQL” is not displayed.
 - If “SQL” appears, push [F] then [2 SQL] to turn OFF the squelch.
 - “SP” is not displayed.
 - If “SP” is displayed, push [F] then [4 SP^x] to activate the speaker.
 - The clarity function is OFF.
 - If the clarity function is ON, push [F] then [RX CLAR] to turn OFF the function.

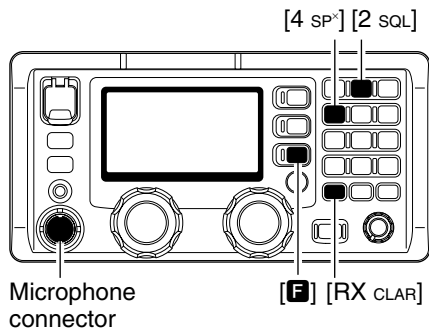

- ② Rotate [GRP] and [CH] to select the desired channel to receive.
 - When receiving a signal, the S-meter shows the signal strength.
- ③ Adjust [VOL] to the desired audio level when receiving a signal.
- ④ Push [MODE SET] to select the desired operating mode.
- ⑤ Push [TUNE THRU] to tune the antenna tuner, if connected.
 - Skip this step when “AUTO TUNE” is set to ON in the initial set mode (p. 51).
- ⑥ To transmit on the channel, hold down the PTT switch on the microphone.
 - “TUNE” blinks for 1 to 2 seconds for the first transmission on a channel when the automatic tuning function is ON.
- ⑦ Speak into the microphone at your normal voice level.
 - The RF meter shows the output power according to your voice level.
 - If “SUR” appears, check your antenna system.
- ⑧ Release the PTT switch to receive.

Functions for transmit

◇ Transmit frequency check

When “DF” is displayed in the display such as on a ship-to-ship channel, the transmit frequency differs from the receive frequency.

In such cases, the transmit frequency should be monitored before transmitting, to prevent interfering with other stations.

- Push [F] then hold down [TX TXF] to monitor the transmit frequency.

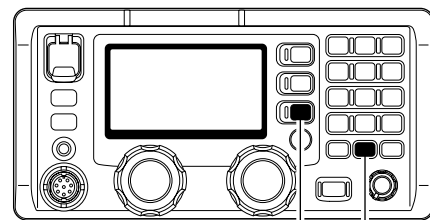

- “TX” blinks and the display shows the transmit frequency.

◇ Transmit power selection

The transceiver has 3 selectable power output levels. High power allows longer distance communications and low power reduces power consumption.

- ① Push [F].
 - “P” appears.
- ② Push either [7 Lo], [8 Mid] or [9 Hi] to select low, mid or high output power, respectively.
 - The display shows the selected output power level for approximately 2 seconds, then returns to the previous display.

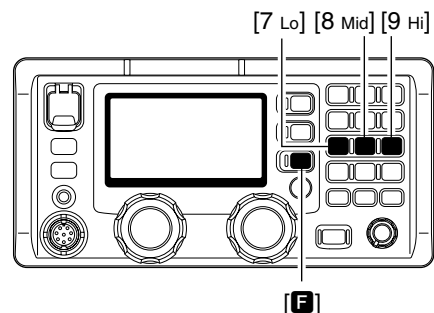

■ Functions for receive

◇ Squelch function

The squelch function detects signals with voice components and squelches (mutes) unwanted signals such as unmodulated beat signals. This provides quiet stand-by.

When you need to receive weak signals, turn OFF the squelch.

- ➔ Push [F] then [2 SQL] to turn the function ON or OFF.
- See page 50 for squelch level adjustment details.

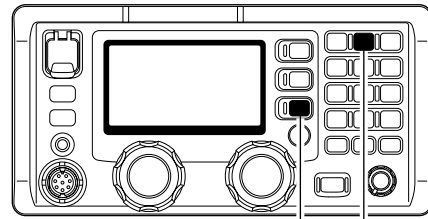

[F] [2 SQL]

- “SQL” appears when the squelch function is turned ON.

◇ Noise blanker

The noise blanker function reduces pulse type noise such as that coming from engine ignitions.

The noise blanker may distort reception of strong signals. In such cases, the noise blanker should be turned OFF.

- ➔ Push [F] then [1 NB] to turn the function ON or OFF.
- See page 50 for noise blanker level adjustment details.

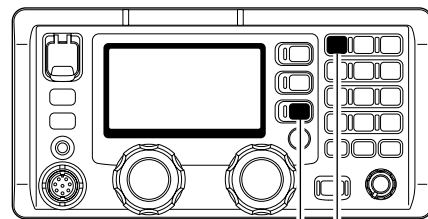

[F] [1 NB]

- “NB” appears when the NB function is turned ON.

◇ AGC OFF function

The receive gain is automatically adjusted according to received signal strength with the AGC (Automatic Gain Control) function to prevent distortion from strong signals and to obtain a constant output level.

When receiving weak signals with adjacent strong signals or noise, the AGC function may reduce the sensitivity. In such cases, turn OFF the AGC function.

- ➔ Push [F] then [5 AGC[×]] to turn the function ON or OFF.

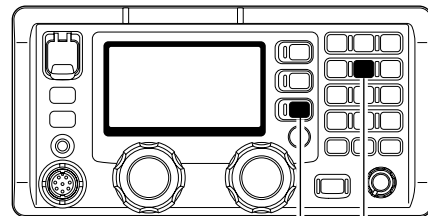

[F] [5 AGC[×]]

- “AGC” appears when the AGC function is turned OFF.

◇ RF gain setting

The receiver gain can be reduced with the RF gain setting. This may help to remove undesired weak signals while monitoring strong signals.

Usually, the AGC function reduces the RF gain according to the receive signal strength, and these weak signals are removed. However, when no signal is received, these weak signals may not be heard.

In such cases, the RF gain may be useful to set a minimum level at which to hear signals.

- ① Push [F] then [6 RF-G] to select the RF gain set mode, as shown below.

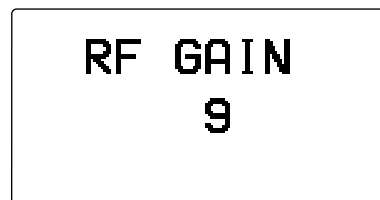

- ② Rotate [CH] to set the desired minimum cutting level.
 - “0 (low sensitivity)” to “9 (maximum sensitivity)” can be set.
 - The S-meter shows the minimum permitted level.
- ③ Push any key to exit the RF gain set mode.

■ Functions for receive (continued)

◇ Clarity control

Voice signals received from other stations may be difficult to receive. This may happen if a station is transmitting slightly off frequency. In such cases, you can compensate by using the clarity control.

- ① Push **[F]** then [RX CLAR] to turn the function ON or OFF.
 - “CLAR” and the shifting value and direction appear.
- ② Rotate [CH] to improve the audio readability.
 - Adjustable between ± 150 Hz in 10 Hz steps.

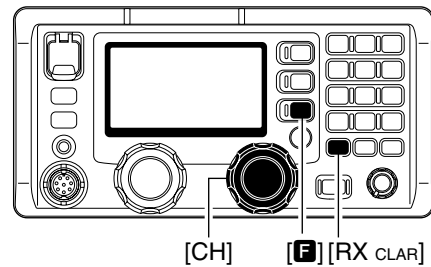

◇ Tuner through function

In the combination with IC-M802 and optional AT-140 (or AH-3), the Tuner Through function can be used.

By bypassing the tuner unit, the receiver gain in a particular frequency band may be improved, depending on your antenna element length.

- ➔ While “TUNE” is displayed, push **[F]** then [TUNE THRU] to turn ON the Tuner Through function.
 - “THRU” appears instead of “TUNE”.
 - Push [TUNE THRU] to turn OFF the function.

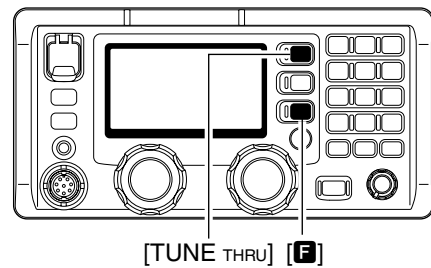

■ CW operation

The transceiver has the following CW keying features selectable in the Set mode, as described on page 53.

- ➔ Full break-in (Immediately returns to receive when you release a key)
- ➔ Semi break-in (Returns to receive after a preset delay time has passed after you stop keying.)
- ➔ OFF (manual transmission with microphone's [PTT], or grounding the SEND line of the [ACC] connector is necessary before keying)

- ① Connect a CW keyer or an external electronic keyer to the [ACC] socket, as shown to the right.
- ② Select the desired channel to operate in the CW mode.
- ③ If the selected channel is not in the A1A (CW) mode, push [MODE SET] several times to select "A1A."
- ④ Operate the CW keyer to transmit a CW signal.

CW key connection

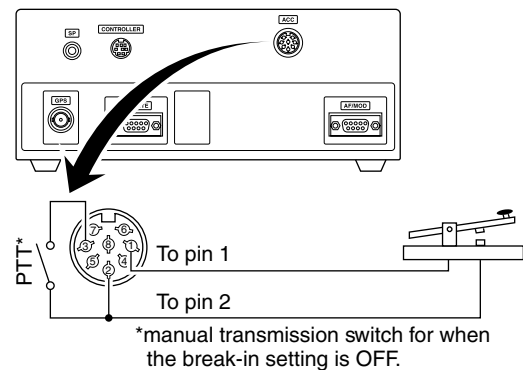

■ FSK operation

The transceiver has F1B and J2B modes for FSK operation—, select F1B when using the built-in oscillator; select J2B when using an AFSK terminal unit.

- ① Connect an FSK terminal unit to the [ACC] socket as shown to the right.
- ② Select the desired channel to operate in the FSK mode.
 - FSK ITU channel group, Ch 4001 to Ch 25040, are only usable when the SITOR CH setting is set to ON. (p. 51)
- ③ Push [MODE SET] several times to select F1B or J2B.
- ④ Operate using the FSK terminal unit.

NOTE:

- ➔ FSK tone, shift frequency and FSK polarity can be adjusted in the initial set mode. (p. 53)
- ➔ Some transceivers may operate 1.7 kHz higher than the IC-M802's J2B mode, even when the same displayed frequencies are is selected.

FSK terminal unit connection

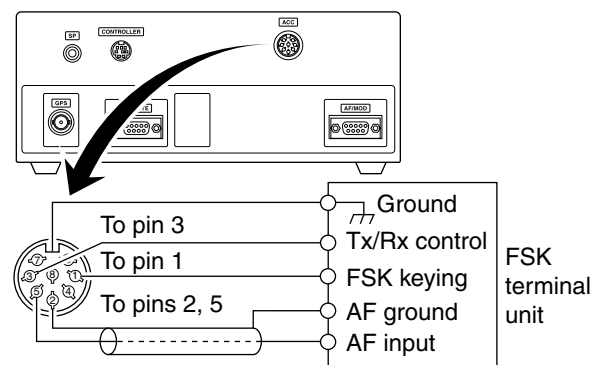

Channel names of up to 8 characters can be assigned to each user and ITU channel. This may be helpful to indicate the frequency used, ship name, and so on.

NOTE: The display type must be set to "CHANNEL" to display/program the channel names in the initial set mode. (p. 52).

◇ Programming

- ① Select the desired channel to be programmed.
- ② Push [FREQ/CH] to select the channel display mode.
- ③ Push [F] then [FREQ/CH].
 - The 1st character of the channel names blinks.

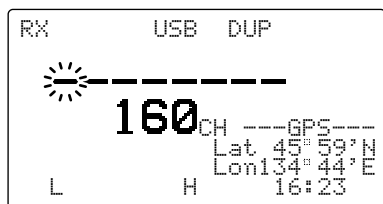

The cursor automatically moves to the right. When you want to change the cursor position, rotate the [CH].

- ⑤ Push [ENT] to set the channel name.

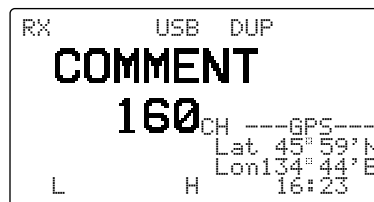

- ④ Push the keypad several times to enter the desired character.
 - See the table below for usable character

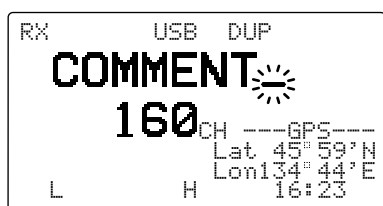

• Usable characters

KEY	CHARACTERS	KEY	CHARACTERS
1 NB QZ	1 Q Z q z (space)	6 RF-G MNO	6 M N O m n o
2 SQL ABC	2 A B C a b c	7 Lo PRS	7 P R S p r s
3 SCAN DEF	3 D E F d e f	8 Mid TUV	8 T U V t u v
4 SP ^x GHI	4 G H I g h i	9 Hi WXY	9 W X Y w x y
5 AGC ^x JKL	5 J K L j k l	0 DIM - /	0 - / . ' () * + < = > @

■ MMSI code programming

When no 9 digit MMSI (Maritime Mobile Service Identity DSC self ID) code has been programmed, follow the instructions below.

/// You cannot program the MMSI code if it has already been programmed. The code is displayed on the screen every time you turn ON the power.

/// **NOTE:** The programming can only be done once. If you make a mistake, you must take the transceiver to your dealer.

◇ Programming

- ① When turning ON the power, you will see the warning screen below and hear an alarm.



- ② Push any key to turn the warning OFF. The channel indication screen is displayed.

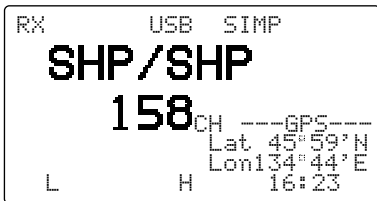

- ③ Push [DSC] to display the MMSI code programming screen.

- ④ Enter the specified 9 digit MMSI code using the keypad.

- Make sure the correct code is entered.
- Rotate [CH] to move the cursor.



- ⑤ Push [ENT] to set the code.



Position and time programming

When no GPS receiver is connected to the [GPS] connector, the position and the UTC time should be manually input for the DSC operation.

IMPORTANT!

The manually programmed position and the UTC time settings will be cleared once the power is turned OFF. They are never renewed during the voyage when the position is set manually.

- 1 The transceiver must be OFF. Then, while holding down [MODE SET] push [POWER] to enter initial set mode.

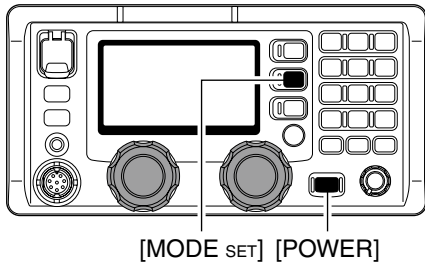

- 2 Rotate [GRP] to select the "GPS DISPLAY" then rotate [CH] to select the desired position display type either Simple or Detail.



- 3 Rotate [GRP] to select the "OFFSET TIME", then rotate [CH] to set the time difference between local and the UTC time, between -12 to +12 hours, in 10 minute steps.



- 4 Turn OFF the power once, then ON again to exit the Quick set mode.

When a GPS receiver is connected to [GPS], the following steps are not necessary.

- 5 Push [DSC] to select the DSC watch mode.
- 6 Push [MODE SET] to open the DSC menu.
 - The DSC menu is displayed, as shown below.
- 7 Rotate [CH] to select "Position," then push [ENT].



- 8 Enter your position and the UTC time using the keypad, then push [ENT].
 - Push [3 SCAN] for the 'East,' [9 H] for the 'West,' [6 RF-G] for the 'North' and [7 L] for the 'South' setting.
 - The degree and minute digits can only be entered when "DETAIL" is selected as the position display in step 2. The seconds digit shows only "0".
 - Rotate [CH] to move the cursor.

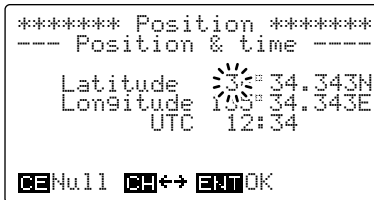

- 9 Push [ENT] to program the position and time.
 - Return to the "DSC MENU" display as in step 7.
- 10 Push [MODE SET] to exit the DSC menu.
 - Rotate [CH] to select "Exit", then push [ENT] will also exit the set mode.
 - "MNL" appears instead of "GPS."

Simple position display



Detail position display



Distress Call

A distress call should be transmitted, if in the opinion of the Master, the ship or a person is in distress and requires immediate assistance.

A distress call should include the ship's position and time. They are automatically included when a GPS receiver is connected to [GPS]. When no GPS is connected, input them, if possible.

A distress call is also called a "MAYDAY call."

NEVER USE THE DISTRESS CALL WHEN YOUR SHIP OR A PERSON IS NOT IN AN EMERGENCY. DISTRESS CALLS CAN BE USED ONLY WHEN IMMEDIATE HELP IS NEEDED.

Distress call outline

Simple distress call

Hold down [DISTRESS] for 5 seconds.

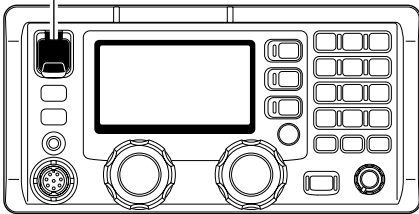

Regular distress call

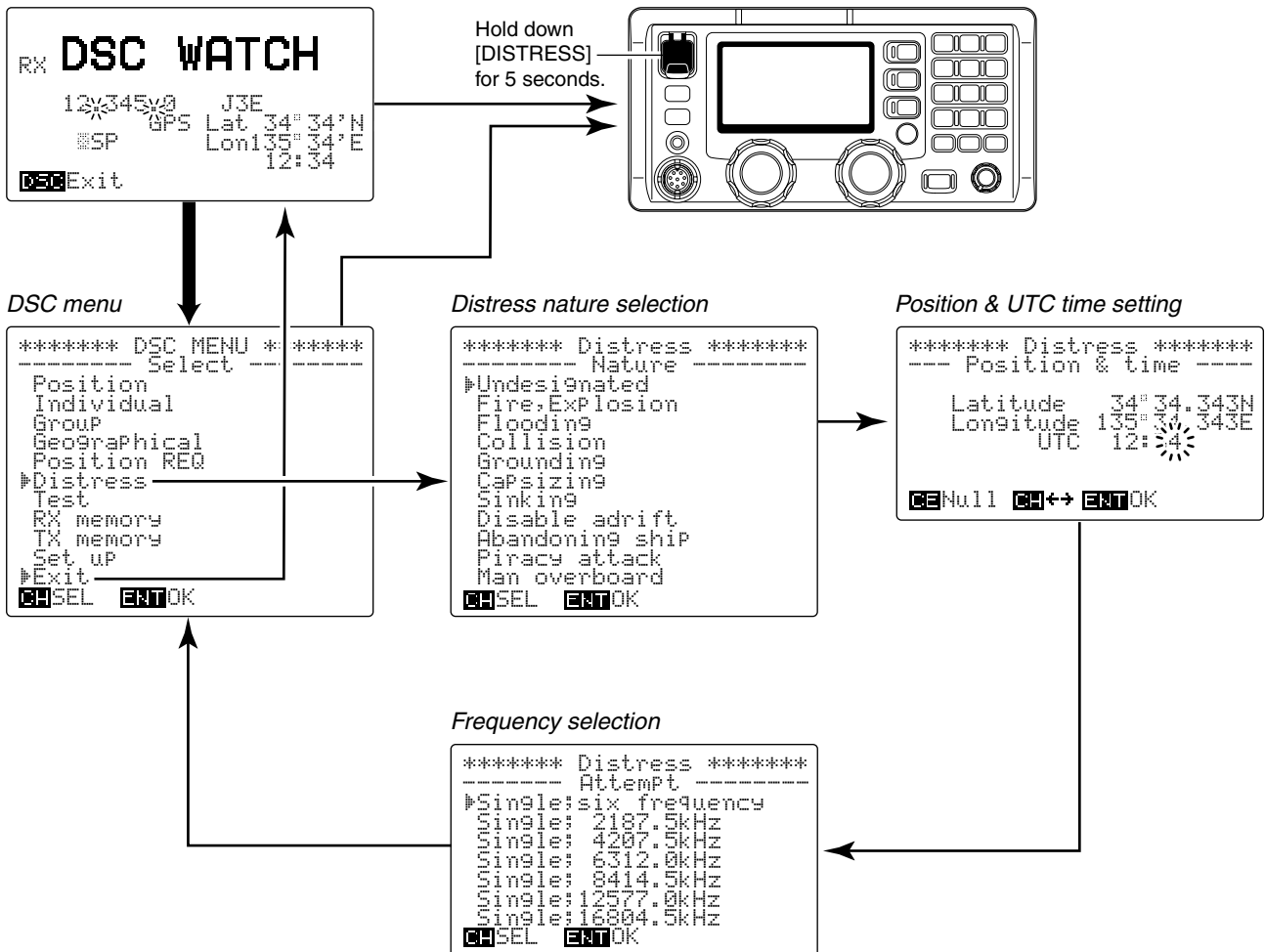

◇ Simple distress call

NOTE:

- Distress alert simple operation defaults are:
Distress nature : Undesignated distress.
Position data : According to the displayed information.
- The distress call is repeated every 3.5–4.5 minutes, until receiving an acknowledgement.
- A beep (Pi, Pi) sounds at the maximum audio level every 1 second.

- Hold down [DISTRESS] for 5 seconds to transmit a renewed distress call, if desired.
- Push [CANCEL/CALL] to cancel the call repeat mode.
The cancel acknowledgement is automatically transmitted when the [CANCEL/CALL] is pushed.

- ① Confirm a distress call is not being received.
- ② Lift up the distress switch cover, then hold down [DISTRESS] for 5 seconds to transmit the distress call.
 - An emergency frequency (default: 8414.5 kHz) is automatically selected and the distress call is transmitted.
 - If you have time, make the distress call in regular way (p. 19).
 - When no GPS receiver is connected, your location and UTC time should be input.

[DISTRESS]

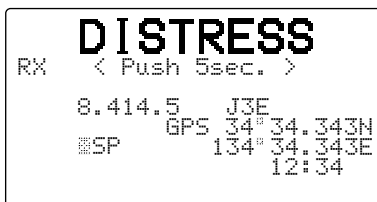
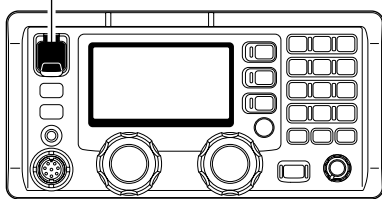

After 5 seconds,
starts distress call.

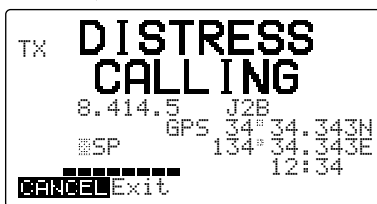

- ③ After transmitting the call, the transceiver is automatically set to the phone emergency frequency (Example: 2182.0 kHz).
 - The DSC receiver circuit is still working to receive an acknowledgement call on the previous frequency (e.g. 2187.5 kHz).

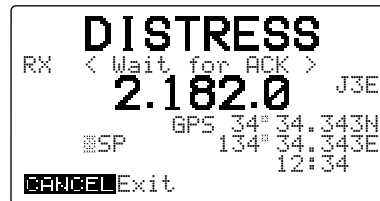

- ④ When you receive an acknowledgement, push [CANCEL/CALL] to stop the alarm, then reply to the connected station using the transceiver's microphone.
 - The acknowledgement is memorized into the RX memory channel. (p. 40)

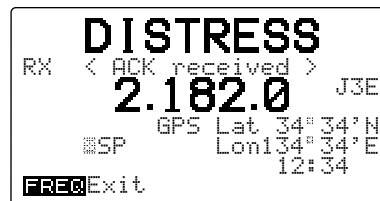

/// Activate an EPIRB (Emergency Position Indicating Radio Beacon) and prepare a SART (Search And Rescue Transponder) and VHF marine handheld transceiver before launching a survival craft.

◇ Regular distress call

Transmit a distress call after selecting “Distress” in the DSC menu.

NEVER USE THE DISTRESS CALL WHEN YOUR SHIP OR A PERSON IS NOT IN AN EMERGENCY. DISTRESS CALLS CAN BE USED ONLY WHEN IMMEDIATE HELP IS NEEDED.

- ① Push [DSC] to select the DSC watch mode.
- ② Push [MODE set] to select the DSC menu.

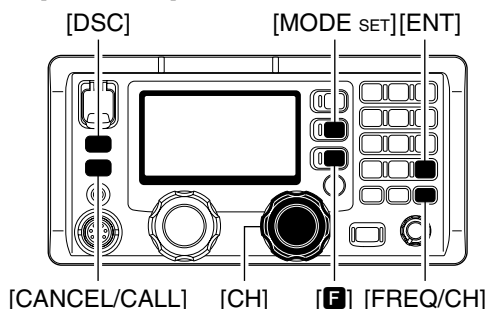

- ③ Rotate [CH] to select “Distress,” then push [ENT].

```

***** DSC MENU *****
----- Select -----
Position
Individual
Group
Geographical
Position REQ
▶Distress
Test
RX memory
TX memory
Set up
Exit
[CH]SEL [ENT]OK

```

- ④ Rotate [CH] to select the desired nature of the situation, then push [ENT].

```

***** Distress *****
----- Nature -----
▶Undesignated
Fire,Explosion
Flooding
Collision
Grounding
Capsizing
Sinking
Disable adrift
Abandoning ship
Piracy attack
Man overboard
[CH]SEL [ENT]OK

```

- ⑤ Verify the position and UTC time data, then push [ENT].
 - When no GPS receiver is connected, your location and UTC time should be input in this step.

```

***** Position *****
--- Position & time ---
Latitude 34° 34.343N
Longitude 104° 34.343E
UTC 12:34
[ENT]Null [CH]↔ [ENT]OK

```

- ⑥ Rotate [CH] to select the desired distress frequency, then push [ENT].

- After pushing [ENT], return to the DSC menu as shown in step ①.

```

***** Distress *****
----- Attempt -----
▶Single:six frequency
Single: 2187.5kHz
Single: 4207.5kHz
Single: 6312.0kHz
Single: 8414.5kHz
Single: 12577.0kHz
Single: 16804.5kHz
[CH]SEL [ENT]OK

```

- ⑦ Lift up the distress switch cover, push [DISTRESS] for 5 seconds to transmit the distress call.

- The distress call is transmitted on the emergency frequency selected in step ⑥.

- ⑧ After transmitting the call, the transceiver is set to the phone emergency frequency automatically.

- The DSC receiver circuit is still working to receive an acknowledgement call on the previous frequency.

- The distress call transmission and acknowledgement reception are performed on the all distress frequencies (2187.5, 4207.5, 6312.0, 8414.5, 12577.0 and 16804.5 kHz) in sequence when “Single:six frequency” is selected in step ⑥.

```

DISTRESS
RX < Wait for ACK >
2.182.0 J3E
GPS 34° 34.343N
SP 134° 34.343E
12:34
[CANCEL]Exit

```

- ⑨ When receiving an acknowledgement, push [CANCEL/CALL] to stop the alarm then reply to the connected station using the transceiver’s microphone.

- The acknowledgement is memorized into the RX memory channel. (p. 40)

◇ **When no acknowledgement is received**

If no acknowledgement is received, the IC-M802 automatically transmits the distress call again every 3.5 to 4.5 minutes.

- After several minutes, a distress relay call may be received from another ship if an acknowledgement cannot be directly received from a coast station.

CAUTION!

DO NOT push [CANCEL/CALL] while waiting for an acknowledgement, otherwise the distress call repeat is cancelled.

Push [CANCEL/CALL] only when you intentionally want to cancel repeated transmission.

◇ **After receiving an acknowledgement call**

Speak into the microphone and give the following information after receiving a distress acknowledgement from a coast station or another ship.

- “MAYDAY”
- “This is (your ship name).”
- The 9-digit identity **AND** the call sign (or other identification of the ship).
- The ship’s position if the DSC distress does not included it.
- The nature of the distress and assistance required.
- Any other information which might facilitate the rescue.

■ Distress call to ships

General DSC calls with the “distress” category may be sent after the Distress call. For example, you want to change the operating frequency, and so on.

The call is transmitted one time only although the distress call using the [DISTRESS] switch is repeated 5 times.

◇ Operation Outline

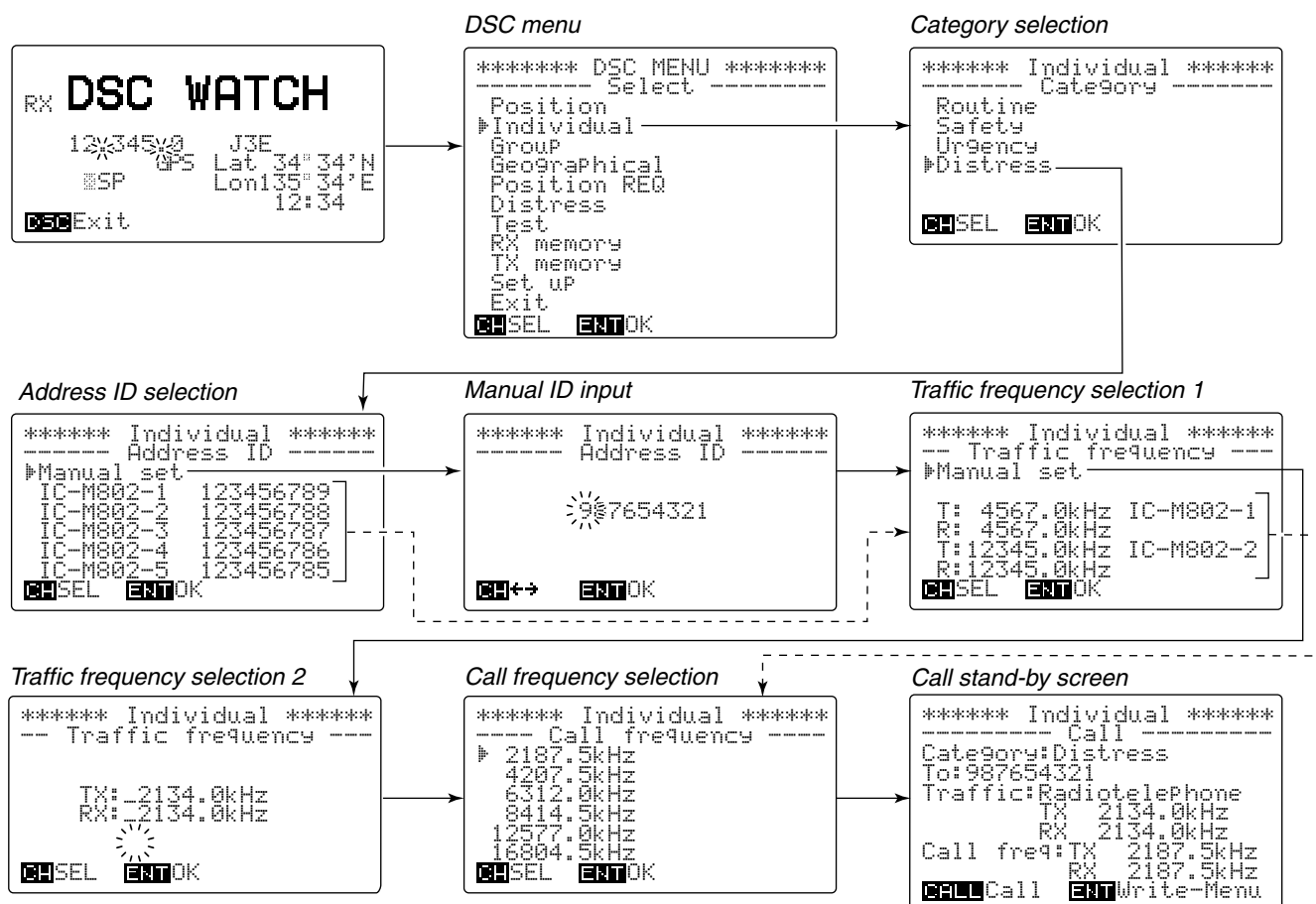

Hold down [CANCEL/CALL] for 1 second to start calling.

Hold down [ENT] for 1 second to store the information into a TX memory channel.

◇ Distress call to ships

- ① Push [DSC] to select the DSC watch mode.
- ② Push [MODE SET] to select the DSC menu.

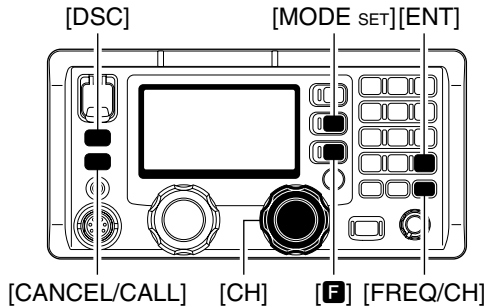

- ③ Rotate [CH] to select "Individual," then push [ENT].
- ④ Rotate [CH] to select "Distress," then push [ENT].

```
***** Individual *****
----- Category -----
Routine
Safety
Urgency
▶Distress
[CHSEL] [ENT]OK
```

- ⑤ Rotate [CH] to select the desired preprogrammed ID, or "Manual set," then push [ENT].
- ✓ When preprogrammed ID is selected, go to step ⑦.

```
***** Individual *****
----- Address ID -----
▶Manual set
IC-M802-1 123456789
IC-M802-2 123456788
IC-M802-3 123456787
IC-M802-4 123456786
IC-M802-5 123456785
[CHSEL] [ENT]OK
```

- ⑥ Enter the desired 9-digit MMSI code using the keypad.
- ✓ The number "0 (zero)" cannot be entered as the 1st digit, since the 1st digit "0" means a group code.

```
***** Individual *****
----- Address ID -----
☀:7654321
[CH]↔ [ENT]OK
```

- ⑦ Rotate [CH] to select the desired preprogrammed traffic frequency, or "Manual set," then push [ENT].
- ✓ When preprogrammed traffic frequency is selected, go to step ⑨.

```
***** Individual *****
-- Traffic frequency --
▶Manual set
T: 4567.0kHz IC-M802-1
R: 4567.0kHz
T:12345.0kHz IC-M802-2
R:12345.0kHz
[CHSEL] [ENT]OK
```

- ⑧ Enter the desired transmit and receive traffic frequency using the keypad, then push [ENT].

```
***** Individual *****
-- Traffic frequency --
TX:☀134.0kHz
RX:☀2134.0kHz
[CHSEL] [ENT]OK
```

- ⑨ Rotate [CH] to select the desired calling frequency, then push [ENT].

```
***** Individual *****
----- Call frequency -----
▶2187.5kHz
4207.5kHz
6312.0kHz
8414.5kHz
12577.0kHz
16804.5kHz
[CHSEL] [ENT]OK
```

- ⑩ The call stand-by screen is displayed as follows. Verify the calling information then hold down [CANCEL/CALL] for 1 second to start calling.

```
***** Individual *****
----- Call -----
Category:Distress
To:987654321
Traffic:RadiotelePhone
TX 2134.0kHz
RX 2134.0kHz
Call freq:TX 2187.5kHz
RX 2187.5kHz
[CALL]Call [ENT]Write-Menu
```

- ⑪ After the call, wait for an acknowledgement call.
- The calling is made only one time.

```
Individual
< Wait for ACK >
RX 2.187.5 J2B
GPS Lat 34°34'N
Lon135°34'E
12:34
[FREQ]Exit
```

⑫ When receiving the acknowledgement call, the display shows the received ID code, or the calling station name.

- Push [FREQ/CH];
 - to select the traffic frequency if the called station is able to comply to the call.
 - to return to DSC watch mode when unable.

```
*****
*   Individual ACK   *
*   IC-M802         *
*   Able to comply  *
*****
[FREQ]Exit
```

```
*****
*   Individual ACK   *
*   IC-M802         *
*   Unable to comply *
*****
[FREQ]Exit
```

When the called station is unable to comply to the call, the reason may be displayed.

✓ CONVENIENT!

The IC-M802 has DSC TX memory. You can store often used DSC calls for quick and simple re-call. Up to 10 calls can be stored into the memory with the following instructions.

- 1 When call stand-by screen is displayed as in step ⑩ at left, hold down [ENT] for 1 second.
- 2 Rotate [CH] to select the desired TX memory channel number.

```
***** Individual *****
--- TX memory write ---
#0:
1:
2:
3:
4:
5:
[CH]SEL [ENT]Write
```

- 3 Hold down [ENT] for 1 second again to store the Call into the selected memory channel.

```
***** Individual *****
--- TX memory write ---
#0: Individual 987654321
1:
2:
3:
4:
5:
[CH]SEL [ENT]OK
```

- 4 Push [ENT] to return to the calling stand-by screen.

```
***** TX memory *****
----- Individual -----
Category:Distress
To:987654321
Traffic:Radiotelephone
TX 2134.0kHz
RX 2134.0kHz
Call freq:TX 2187.5kHz
RX 2187.5kHz
[CALL]Call [C]DEL
```

- 5 Hold down [CANCEL/CALL] for 1 second when transmitting the DSC call in set mode, or push [MODE SET] when returning to DSC watch mode.

■ Urgency call

When you want to send an urgency message, such as medical transport announcement, or other urgent situation, to other ships, use "Urgency" as the category.

An urgency call is sometimes called a "PAN PAN call."

◇ Operation outline

DSC menu

```
***** DSC MENU *****
----- Select -----
Position
▶Individual
Group
Geo9raphical
Position REQ
Distress
Test
RX memory
TX memory
Set up
Exit
[CH]SEL [ENT]OK
```

Category selection

```
***** Individual *****
----- Category -----
Routine
Safety
▶Urgency
Distress
[CH]SEL [ENT]OK
```

Category selection

```
***** Geo9raphical *****
----- Category -----
Safety
▶Urgency
[CH]SEL [ENT]OK
```

Address ID selection

```
***** Individual *****
----- Address ID -----
▶Manual set
IC-M802-1 123456789
IC-M802-2 123456788
IC-M802-3 123456787
IC-M802-4 123456786
IC-M802-5 123456785
[CH]SEL [ENT]OK
```

Area selection

```
***** Geo9raphical *****
----- Area -----
▶Centre-Point
Area
[CH]SEL [ENT]OK
```

Manual ID input

```
***** Individual *****
----- Address ID -----
☀:7654321
[CH]↔ [ENT]OK
```

Centre-point input

```
***** Geo9raphical *****
----- Centre-Point -----
Latitude ☀:--'N
Longitude ☀:--'W
Range:_500nm
[CH]↔ [ENT]OK
```

Area input

```
***** Geo9raphical *****
----- Area -----
Latitude ☀:--'N
Longitude ☀:--'W
[CH]↔ [ENT]OK
```

Traffic frequency selection 1

```
***** Geo9raphical *****
***** Individual *****
--- Traffic frequency ---
▶Manual set
T: 4567.0kHz IC-M802-1
R: 4567.0kHz
T:12345.0kHz IC-M802-2
R:12345.0kHz
[CH]SEL [ENT]OK
```

Traffic frequency selection 2

```
***** Geo9raphical *****
***** Individual *****
--- Traffic frequency ---
☀:2134.0kHz
TX:2134.0kHz
RX:2134.0kHz
[CH]SEL [ENT]OK
```

Call frequency selection

```
***** Geo9raphical *****
***** Individual *****
--- Call frequency ---
▶2187.5kHz
4207.5kHz
6312.0kHz
8414.5kHz
12577.0kHz
16804.5kHz
[CH]SEL [ENT]OK
```

Confirmation screen

```
***** Geo9raphical *****
***** Individual *****
----- Call -----
Category:Urgency
To:987654321
Traffic:Radiotelephone
TX 2134.0kHz
RX 2134.0kHz
Call freq:TX 2187.5kHz
RX 2187.5kHz
[CALL]Call [ENT]Write-Menu
```

Hold down [CANCEL/CALL] for 1 second to start calling.
Hold down [ENT] for 1 second to store the information into the TX memory channel.

◇ Urgency call operation

- ① Push [MODE SET] to select the DSC menu.
- ② Rotate [CH] to select either “Individual” or “Geographical” then push [ENT].

• When selecting “Geographical”

- ③ Rotate [CH] to select “Urgency,” then push [ENT].

```
***** Geographical *****
----- Category -----
Safety
▶Urgency

[CH]SEL [ENT]OK
```

- ④ Rotate [CH] to select the desired area designated method, then push [ENT].

```
***** Geographical *****
----- Area -----
▶Centre-Point
Area

[CH]SEL [ENT]OK
```

- ⑤ Enter the position information (latitude and longitude) with range or area, then push [ENT].
- When “Centre-Point” is selected

```
***** Geographical *****
----- Centre-Point -----

Latitude  ☀ ° __ 'N
Longitude  ☀ ° __ 'W
Range: 500nm

[CH]↔ [ENT]OK
```

- When “Area” is selected

```
***** Geographical *****
----- Area -----

Latitude  ☀ ° N-H: __
Longitude  ☀ ° W-V: __

[CH]↔ [ENT]OK
```

- ⑥ Rotate [CH] to select a traffic frequency from one of the preprogrammed frequencies or “Manual set” then push [ENT].
- ✓ When a preprogrammed frequency is selected, go to step ⑧.

```
***** Geographical *****
-- Traffic frequency --
▶Manual set

T: 4567.0kHz IC-M302-1
R: 4567.0kHz
T: 12345.0kHz IC-M302-2
R: 12345.0kHz

[CH]SEL [ENT]OK
```

- ⑦ Enter the desired traffic frequencies for both the transmit and receive, then push [ENT].

```
***** Geographical *****
-- Traffic frequency --

TX: ☀ 134.0kHz
RX: ☀ 2134.0kHz

[CH]SEL [ENT]OK
```

- ⑧ Rotate [CH] to select the desired calling channel, then push [ENT].

```
***** Geographical *****
----- Call frequency -----
▶ 2187.5kHz
4207.5kHz
6312.0kHz
8414.5kHz
12577.0kHz
16804.5kHz

[CH]SEL [ENT]OK
```

- ⑨ After the calling stand-by screen appears, hold down [CANCEL/CALL] for 1 second to transmit the urgency call.
- The transceiver is set to the traffic frequency after the call transmission.
- Hold down [ENT] for 1 second to store the calling information into the TX memory described in pages 23 and 45, if desired.

```
***** Geographical *****
----- Call -----
Category:Urgency
Traffic:RadiotelePhone
TX 2134.0kHz
RX 2134.0kHz
Call freq:TX 2187.5kHz
RX 2187.5kHz

[CALL]Call [ENT]write-Menu
```

- ⑩ Announce the following message.

- “PAN PAN”
- “All stations” (repeat 3 times).
- “This is (your ship name).”
- The 9-digit identity **AND** the call sign (or other identification of the ship).
- The text of the urgency message.

• When selecting “Individual”

- ③ Select “Urgency” as the category using [CH], then push [ENT].

```
***** Individual *****
----- Category -----
Routine
Safety
▶Urgency
Distress
[CH]SEL [ENT]OK
```

- ④ Select (or enter) the 9-digit ID code, then push [ENT].
 • Use [CH] to select the ID code when the desired ship's ID is preprogrammed.

```
***** Individual *****
----- Address ID -----
▶Manual set
IC-M802-1 123456789
IC-M802-2 123456788
IC-M802-3 123456787
IC-M802-4 123456786
IC-M802-5 123456785
[CH]SEL [ENT]OK
```

- Select “Manual set.” with [CH] then push [ENT], after that, enter the desired 9-digit ID using the keypad.

```
***** Individual *****
----- Address ID -----
☀7654321
[CH]↔ [ENT]OK
```

- ⑤ Rotate [CH] to select the desired preprogrammed traffic frequency, or “Manual set” then push [ENT].
 ✓ When preprogrammed traffic frequency is selected, go to step ⑦.

```
***** Individual *****
-- Traffic frequency --
▶Manual set
T: 4567.0kHz IC-M802-1
R: 4567.0kHz
T: 12345.0kHz IC-M802-2
R: 12345.0kHz
[CH]SEL [ENT]OK
```

- ⑥ Enter the desired transmit and receive traffic frequency using the keypad, then push [ENT].

```
***** Individual *****
-- Traffic frequency --
TX☀134.0kHz
RX:2134.0kHz
[CH]SEL [ENT]OK
```

- ⑦ Rotate [CH] to select the desired calling frequency, then push [ENT].

```
***** Individual *****
----- Call frequency ----
▶ 2187.5kHz
4207.5kHz
6312.0kHz
8414.5kHz
12577.0kHz
16804.5kHz
[CH]SEL [ENT]OK
```

- ⑧ The calling stand-by screen is displayed as follows. Verify the calling information then hold down [CANCEL/CALL] for 1 second to transmit the call.
 • Hold down [ENT] for 1 second to store the calling information into the TX memory described in pages 23 and 45, if desired.

```
***** Individual *****
----- Call -----
Category:Urgency
To:987654321
Traffic:Radiotelephone
TX 2134.0kHz
RX 2134.0kHz
Call freq:TX 2187.5kHz
RX 2187.5kHz
[CALL]Call [ENT]Write-Menu
```

- ⑨ After sending the call, the transceiver waits for an acknowledgement.

```
Individual
< Wait for ACK >
RX 2.187.5 J2B
GPS Lat 34° 34' N
SP Lon135° 34' E
12:34
[FRQ]Exit
```

⑩ When receiving an acknowledgement, the display shows the received ID code, or the called station name.

- Push [FREQ/CH];
 - to select the traffic frequency if the called station is able to comply to the call.
 - to return to DSC watch mode when unable.

```
*****
*   Individual ACK   *
*   IC-M802         *
*   Able to comply  *
*****
[FREQ]Exit
```

```
*****
*   Individual ACK   *
*   IC-M802         *
*   Unable to comply *
*****
[FREQ]Exit
```

When the called station is unable to comply to the call, the reason may be displayed.

⑪ Announce the following message to the selected station.

- “PAN PAN”
- Desired station name (repeated 3 times).
- “This is (your ship name).”
- The 9-digit identity **AND** the call sign (or other identification of the ship).
- The text of the urgency message.

■ Safety call

When you want to send a safety message to other ships, use “Safety” as the category.

A safety call is sometimes called a “SECURITE call.”

◇ Operation outline

DSC menu

```
***** DSC MENU *****
----- Select -----
▶ Individual
Group
Geographical
Position REQ
Distress
Test
RX memory
TX memory
Set uP
Exit
[CH]SEL [ENT]OK
```

Category selection

```
***** Individual *****
----- Category -----
▶ Routine
▶ Safety
Urgency
Distress
[CH]SEL [ENT]OK
```

Category selection

```
***** Geographical *****
----- Category -----
▶ Safety
Urgency
[CH]SEL [ENT]OK
```

Address ID selection

```
***** Individual *****
----- Address ID -----
▶ Manual set
IC-M802-1 123456789
IC-M802-2 123456788
IC-M802-3 123456787
IC-M802-4 123456786
IC-M802-5 123456785
[CH]SEL [ENT]OK
```

Manual ID input

```
***** Individual *****
----- Address ID -----
☀:7654321
[CH]↔ [ENT]OK
```

Area selection

```
***** Geographical *****
----- Area -----
▶ Centre-Point
Area
[CH]SEL [ENT]OK
```

Centre-point input

```
***** Geographical *****
----- Centre-Point -----
Latitude ☀: ___°N
Longitude ___°W
Range: 500nm
[CH]↔ [ENT]OK
```

Area input

```
***** Geographical *****
----- Area -----
Latitude ☀: N-H: ___
Longitude ___°W-U: ___
[CH]↔ [ENT]OK
```

Traffic frequency selection 1

```
***** Geographical *****
***** Individual *****
----- Traffic frequency -----
▶ Manual set
T: 4567.0kHz IC-M802-1
R: 4567.0kHz
T: 12345.0kHz IC-M802-2
R: 12345.0kHz
[CH]SEL [ENT]OK
```

Traffic frequency selection 2

```
***** Geographical *****
***** Individual *****
----- Traffic frequency -----
TX: ☀ 2134.0kHz
RX: ☀ 2134.0kHz
[CH]SEL [ENT]OK
```

Call frequency selection

```
***** Geographical *****
***** Individual *****
----- Call frequency -----
▶ 2187.5kHz
4207.5kHz
6312.0kHz
8414.5kHz
12577.0kHz
16804.5kHz
[CH]SEL [ENT]OK
```

Confirmation screen

```
***** Geographical *****
***** Individual *****
----- Call -----
Category: Safety
To: 987654321
Traffic: Radiotelephone
TX 2134.0kHz
RX 2134.0kHz
Call freq: TX 2187.5kHz
RX 2187.5kHz
[CALL]Call [ENT]Write-Menu
```

Push [CANCEL/CALL] for 1 second to start calling.
Push [ENT] for 1 second to store the information into the TX memory channel.

◇ Safety call operation

- ① Push [MODE SET] to select the DSC menu.
- ② Rotate [CH] to select either “Individual” or “GeoGraphical,” then push [ENT].

• When selecting “GeoGraphical”

- ③ Rotate [CH] to select “Safety,” then push [ENT].

```
***** GeoGraphical *****
----- Category -----
▶Safety
  Urgency
[CH]SEL [ENT]OK
```

- ④ Rotate [CH] to select the desired area designated method, then push [ENT].

```
***** GeoGraphical *****
----- Area -----
▶Centre-Point
  Area
[CH]SEL [ENT]OK
```

- ⑤ Enter the position information (latitude and longitude) with range or area, then push [ENT].
 - When “Centre-Point” is selected

```
***** GeoGraphical *****
----- Centre-Point -----
Latitude  ☀° --'N
Longitude  ° --'W
Range: 500nm
[CH]↔ [ENT]OK
```

- When “Area” is selected

```
***** GeoGraphical *****
----- Area -----
Latitude  ☀° N-H:--
Longitude  ° W-V:--
[CH]↔ [ENT]OK
```

- ⑥ Rotate [CH] to select a traffic frequency from one of the pre-programmed frequencies or “Manual set” then push [ENT].
 - ✓ When a pre-programmed frequency is selected, go to step ⑧.

```
***** GeoGraphical *****
-- Traffic frequency --
▶Manual set
T: 4567.0kHz IC-M302-1
R: 4567.0kHz
T: 12345.0kHz IC-M302-2
R: 12345.0kHz
[CH]SEL [ENT]OK
```

- ⑦ Enter the desired traffic frequencies for both the transmit and receive, then push [ENT].

```
***** GeoGraphical *****
-- Traffic frequency --
TX: ☀134.0kHz
RX: 2134.0kHz
[CH]SEL [ENT]OK
```

- ⑧ Rotate [CH] to select the desired calling channel, then push [ENT].

```
***** GeoGraphical *****
----- Call frequency -----
▶ 2187.5kHz
  4207.5kHz
  6312.0kHz
  8414.5kHz
  12577.0kHz
  16804.5kHz
[CH]SEL [ENT]OK
```

- ⑨ After the calling stand-by screen appears, hold down [CANCEL/CALL] for 1 second to transmit the safety call.
 - The transceiver is set to the traffic frequency after the call transmission.
 - Hold down [ENT] for 1 second to store the calling information into the TX memory described in pages 23 and 45, if desired.

```
***** GeoGraphical *****
----- Call -----
Category:Urgency
Traffic:RadiotelePhone
TX 2134.0kHz
RX 2134.0kHz
Call freq:TX 2187.5kHz
RX 2187.5kHz
[CALL]Call [ENT]write-Menu
```

- ⑩ Announce the following message.

- “SECURITE” (repeat 3 times).
- “All stations” (repeat 3 times).
- “This is (your ship name).”
- The 9-digit identity **AND** the call sign (or other identification of the ship).
- The text of the safety message.

• When selecting 'Individual'

- ③ Select "Safety" as the category using [CH], then push [ENT].

```
***** Individual *****
----- Category -----
Routine
▶Safety
Urgency
Distress
CHSEL ENTOK
```

- ④ Select the desired 9-digit ID code, then push [ENT].
- Use [CH] to select the ID code when the desired ship's ID is pre-programmed.

```
***** Individual *****
----- Address ID -----
▶Manual set
IC-M802-1 123456789
IC-M802-2 123456788
IC-M802-3 123456787
IC-M802-4 123456786
IC-M802-5 123456785
CHSEL ENTOK
```

- Select "Manual set." with [CH] then push [ENT]. After that, enter the desired 9-digit ID using the keypad.

```
***** Individual *****
----- Address ID -----
☀7654321
CH↔ ENTOK
```

- ⑤ Rotate [CH] to select the desired pre-programmed traffic frequency, or "Manual set." then push [ENT].
- ✓ When the pre-programmed traffic frequency is selected, go to step ⑦.

```
***** Individual *****
-- Traffic frequency --
▶Manual set
T: 4567.0kHz IC-M802-1
R: 4567.0kHz
T:12345.0kHz IC-M802-2
R:12345.0kHz
CHSEL ENTOK
```

- ⑥ Enter the desired transmit and receive traffic frequency using the keypad, then push [ENT].

```
***** Individual *****
-- Traffic frequency --
TX☀134.0kHz
RX☀2134.0kHz
CHSEL ENTOK
```

- ⑦ Rotate [CH] to select the desired calling frequency, then push [ENT].

```
***** Individual *****
----- Call frequency -----
▶ 2187.5kHz
4207.5kHz
6312.0kHz
8414.5kHz
12577.0kHz
16804.5kHz
CHSEL ENTOK
```

- ⑧ The calling stand-by screen is displayed as follows. Verify the calling information then hold down [CANCEL/CALL] for 1 second to transmit the call.
- Hold down [ENT] for 1 second to store the calling information into the TX memory described in pages 23 and 45, if desired.

```
***** Individual *****
----- Call -----
Category:Safety
To:987654321
Traffic:RadiotelePhone
TX 2134.0kHz
RX 2134.0kHz
Call freq:TX 2187.5kHz
RX 2187.5kHz
CALL Call ENT Write-Menu
```

- ⑨ After sending the call, the transceiver waits for an acknowledgement.

```
Individual
< Wait for ACK >
RX 2.187.5 J2B
GPS Lat 34°34'N
SP Lon135°34'E
12:34
FREQ:Exit
```

⑩ When receiving an acknowledgement, the display shows the received ID code, or the called station name.

- Push [FREQ/CH];
 - to select the traffic frequency if the called station is able to comply to the call.
 - to return to DSC watch mode when unable.

```
*****
*   Individual ACK   *
*   IC-M802         *
*   Able to comply  *
*****
[FREQ]Exit
```

```
*****
*   Individual ACK   *
*   IC-M802         *
*   Unable to comply *
*****
[FREQ]Exit
```

When the called station is unable to comply to the call, the reason may be displayed.

⑪ Announce the following message to the selected station.

- “SECURITE” (repeat 3 times)
- Desired station name or “all stations” (repeat 3 times).
- “This is (your ship name).”
- The 9-digit identity **AND** the call sign (or other identification of the ship).
- The text of the safety message.

■ Routine call

When you use DSC for general selective calling, use "Routine" as the category.

- ① Push [MODE SET] to select the DSC menu.
- ② Rotate [CH] to select "Individual" then push [ENT].
- ③ Select "Routine" as the category using [CH], then push [ENT].

```

***** Individual *****
----- Category -----
▶Routine
 Safety
 Urgency
 Distress

[CH]SEL [ENT]OK
    
```

- ④ Select the desired 9-digit ID code, then push [ENT].
 - Use [CH] to select the ID code when the desired ship's ID is pre-programmed.

```

***** Individual *****
----- Address ID -----
▶Manual set
IC-M802-1 123456789
IC-M802-2 123456788
IC-M802-3 123456787
IC-M802-4 123456786
IC-M802-5 123456785

[CH]SEL [ENT]OK
    
```

- Select "Manual set" with [CH] then push [ENT]. After that, enter the desired 9-digit ID using the keypad.

```

***** Individual *****
----- Address ID -----

☀7654321

[CH]↔ [ENT]OK
    
```

- ⑤ Select either "Frequency" or "Position" using [CH], then push [ENT].

```

***** Individual *****
----- Message -----
▶Frequency
 Position

[CH]SEL [ENT]OK
    
```

- When "Frequency" is selected, go to step ⑥.

- When "Position" is selected, enter the position information (latitude and longitude) using the keypad, then push [ENT].

```

***** Individual *****
-- RT with Pos number --

Latitude ☀34'N
Longitude ☀34'E

[CH]Null [CH]↔ [ENT]OK
    
```

- ⑥ Rotate [CH] to select the desired pre-programmed traffic frequency, or "Manual set" then push [ENT].
 - ✓ When pre-programmed traffic frequency is selected, go to step ⑦.

```

***** Individual *****
-- Traffic frequency --
▶Manual set
T: 4567.0kHz IC-M802-1
R: 4567.0kHz
T: 12345.0kHz IC-M802-2
R: 12345.0kHz

[CH]SEL [ENT]OK
    
```

- ⑦ Enter the desired transmit and receive traffic frequency using the keypad, then push [ENT].
 - One of the voice channels, such as Tx/Rx: 2082.5 kHz, 4146.0 kHz, should be used.

```

***** Individual *****
-- Traffic frequency --

TX:☀567.0kHz
RX:☀4567.0kHz

[CH]SEL [ENT]OK
    
```

- ⑧ Rotate [CH] to select the desired pre-programmed calling frequency, or "Manual set" then push [ENT].
 - ✓ When the pre-programmed call frequency is selected, go to step ⑩.

```

***** Individual *****
-- Call frequency --
▶Manual set
T: 2345.0kHz IC-M802-1
R: 2345.0kHz
T: 2177.0kHz SHIP
R: 2177.0kHz

[CH]SEL [ENT]OK
    
```

- ⑨ Enter the desired transmit and receive call frequency using the keypad, then push [ENT].

```
***** Individual *****
----- Call frequency -----

TX: 2345.0kHz
RX: 2345.0kHz

[CALL]SEL [ENT]OK
```

- ⑩ The calling stand-by screen is displayed as follows. Verify the calling information then hold down [CANCEL/CALL] for 1 second to transmit the routine call.

- Hold down [ENT] for 1 second to store the calling information into the TX memory described in pages 23 and 45, if desired.

```
***** Individual *****
----- Call -----
Category: Routine
To: 987654321
Traffic: RadiotelePhone
TX 4567.0kHz
RX 4567.0kHz
Call freq: TX 2345.0kHz
RX 2345.0kHz
[CALL]Call [ENT]Write-Menu
```

- ⑪ After sending the call, the transceiver waits for an acknowledgement.

```
Individual
RX < Wait for ACK >
2.345.0 J2B
GPS Lat 34°34'N
Lon 135°34'E
12:34
[CALL]Exit
```

- ⑫ When receiving an acknowledgement, the display shows the received ID code, or the called station name.

- Push [FREQ/CH];
 - to select the traffic frequency if the called station is able to comply to the call.
 - to return to DSC watch mode when unable.

```
*****
* Individual ACK *
* IC-M302 *
* Able to comply *
*****
[CALL]Exit
```

```
*****
* Individual ACK *
* IC-M302 *
* Unable to comply *
*****
[CALL]Exit
```

When the called station is unable to comply to the call, the reason may be displayed.

- ⑬ Announce the following message to stations.
- The 9-digit identity (or call sign or other identification) of the station which you want to call.
 - "This is (your ship name)."
 - The 9-digit identity **OR** call sign (or other identification of the ship).

When no acknowledgement is received:

- ① Wait for 5 minutes, then call again on the same or a different frequency.
- ② If no acknowledgement is received after a 2nd call, wait for at least 15 minutes before repeating the call.

Geographical call

Use the geographical call when urgency or safety message announcement is necessary to the ships in the particular area.

- ① Push [MODE set] to select the DSC menu.
- ② Rotate [CH] to select the "GeoGraphical," then push [ENT].
- ③ Rotate [CH] to select the category from "Safety" and "Urgency," then push [ENT].

```
***** GeoGraphical *****
----- Category -----
▶Safety
  Urgency

[CH]SEL [ENT]OK
```

- ④ Rotate [CH] to select the desired area designated method, then push [ENT].

```
***** GeoGraphical *****
----- Area -----
▶Centre-Point
  Area

[CH]SEL [ENT]OK
```

- ⑤ Enter the position information (latitude and longitude) with range or area, then push [ENT].
 - When "Centre-Point" is selected

```
***** GeoGraphical *****
----- Centre-Point -----

Latitude  ☀️ ° __ 'N
Longitude  ☀️ ° __ 'W
Range: 500nm

[CH]↔ [ENT]OK
```

- When "Area" is selected

```
***** GeoGraphical *****
----- Area -----

Latitude  ☀️ °N-H: __
Longitude  ☀️ °W-U: __

[CH]↔ [ENT]OK
```

- ⑥ Rotate [CH] to select the desired pre-programmed traffic frequency, or "Manual set" then push [ENT].
 - ✓ When the pre-programmed call frequency is selected, go to step ⑦.

```
***** GeoGraphical *****
-- Traffic frequency --
Manual set

▶T: 2134.0kHz IC-M802-1
R: 2134.0kHz
T: 12345.0kHz IC-M802-2
R: 12345.0kHz

[CH]SEL [ENT]OK
```

- When "Manual set" is selected, enter the desired traffic frequency using the keypad.

```
***** GeoGraphical *****
-- Traffic frequency --

TX ☀️ 182.0kHz
RX ☀️ 2182.0kHz

[CH]↔ [ENT]OK
```

- ⑦ Rotate [CH] to select the desired pre-programmed calling frequency, then push [ENT].

```
***** GeoGraphical *****
----- Call frequency -----
▶ 2187.5kHz
  4207.5kHz
  6312.0kHz
  8414.5kHz
  12577.0kHz
  12577.0kHz
  16804.5kHz

[CH]SEL [ENT]OK
```

- ⑧ The calling stand-by screen is displayed as follows. Verify the calling information then hold down [CALL] for 1 second to transmit the position request call.
 - Hold down [ENT] for 1 second to store the calling information into the TX memory as described in pages 23 and 45, if desired.

```
***** GeoGraphical *****
----- Call -----
To area: 14°N-H: 3
        125°W-U: 3
Category: Safety
Traffic: RadiotelePhone
        TX 2182.0kHz
        RX 2182.0kHz
Call freq: TX 2187.5kHz
           RX 2187.5kHz

[CALL]Call [ENT]Write-Menu
```

- ⑨ After sending the call, the transceiver selects the set traffic frequency automatically.

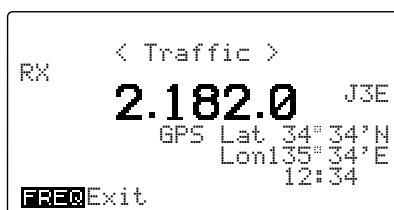

- ⑩ Announce the following message.

- **'Urgency' is selected in step ③**
- "PAN PAN"

- **'Safety' is selected in step ③**
- "SECURITE" (repeat 3 times)

- This is(your ship name)
- The 9-digit identity and the call sign (or other identification of the ship).
- The text of the urgency or safety message.

- ⑪ After the announcement, push [FREQ/CH] to return to DSC watch mode.

✓ For your information—Area input

When using the 'Geographical' call with "Area" selection, your original position is always the upper left hand corner in the world map as in the following illustration.

• Area setting example 1

Latitude 20°N-H:10
Longitude 100°W-V:20

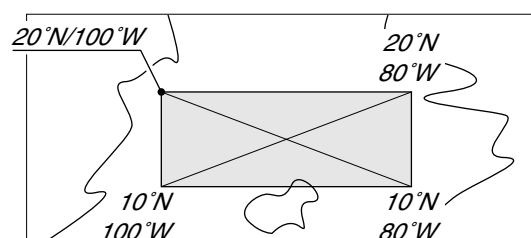

• Area setting example 2

Latitude 20°S-H:10
Longitude 100°E-V:20

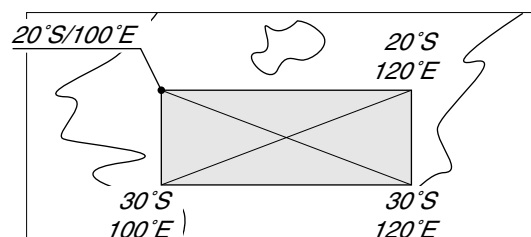

■ Group call

When you use DSC for calling the desired ship's group, use "Group" menu.

- ① Push [MODE SET] to select the DSC menu.
- ② Rotate [CH] to select "Group" then push [ENT].
- ③ Select the desired 9-digit group code, then push [ENT].
 - Use [CH] to select the group code when the desired group is pre-programmed.

```
***** Group *****
----- Group ID -----
▶Manual set
Group-1 023456789
Group-2 023456788
Group-3 023456787
Group-4 023456786
Group-5 023456785
[CH]SEL [ENT]OK
```

- When "Manual set" is selected, enter the desired code (last 8 digits only) using the keypad.
 - The first digit "0 (zero)" is fixed for group code.

```
***** Group *****
----- Group ID -----

        0654321

[CH]↔ [ENT]OK
```

- ④ Rotate [CH] to select the desired pre-programmed traffic frequency, or "Manual set" then push [ENT].
 - ✓ When the pre-programmed traffic frequency is selected, go to step ⑥.

```
***** Group *****
-- Traffic frequency ---
▶Manual set

T: 4567.0kHz IC-M802-1
R: 4567.0kHz
T: 12345.0kHz IC-M802-2
R: 12345.0kHz
[CH]SEL [ENT]OK
```

- ⑤ Enter the desired transmit and receive traffic frequency using the keypad, then push [ENT].
 - One of the voice channel, such as Tx/Rx: 2082.5 kHz, 4146.0 kHz, should be used.

```
***** Group *****
-- Traffic frequency ---

        TX: 2134.0kHz
        RX: 2134.0kHz

[CH]SEL [ENT]OK
```

- ⑥ Rotate [CH] to select the desired pre-programmed calling frequency, or "Manual set" then push [ENT].
 - ✓ When the pre-programmed call frequency is selected, go to step ⑧.

```
***** Group *****
---- Call frequency ----
▶Manual set

T: 2345.0kHz IC-M802-1
R: 2345.0kHz
T: 2177.0kHz SHIP
R: 2177.0kHz
[CH]SEL [ENT]OK
```

- ⑦ Enter the desired transmit and receive call frequency using the keypad, then push [ENT].

```
***** Group *****
---- Call frequency ----

        TX: 2345.0kHz
        RX: 2345.0kHz

[CH]SEL [ENT]OK
```

- ⑧ The calling stand-by screen is displayed as follows. Verify the calling information then hold down [CANCEL/CALL] for 1 second to transmit the group call.
 - Hold down [ENT] for 1 second to store the calling information into TX memory described in pages 23 and 45, if desired.

```
***** Group *****
----- Call -----
To:087654321
Traffic:Radiotelephone
        TX 2134.0kHz
        RX 2134.0kHz
Call Freq:TX 2177.0kHz
        RX 2177.0kHz
[CALL]Call [ENT]Write-Menu
```

- ⑨ After sending the call, the traffic frequency is selected automatically.

```
< Traffic >
RX      2.134.0 J3E
        GPS Lat 34° 34' N
        #SP Lon135° 34' E
        12:34
[FR]Exit
```

- ⑩ Announce the following message to stations.
 - "The group name."
 - "This is (your ship name)."
 - The 9-digit identity **OR** call sign (or other identification of the ship).

■ Position request call

The position request call is used to confirm the specified ship's position. This calling system uses digital signals only, therefore a voice reply is not necessary.

- ① Push [MODE SET] to select the DSC menu.
- ② Rotate [CH] to select the "Position REQ" then push [ENT].
- ③ Select the desired 9-digit ID code, then push [ENT].
 - Use [CH] to select the ID code when the desired ship's ID is pre-programmed.

```

***** Position REQ *****
----- Address ID -----
#Manual set
IC-M302-1 123456789
IC-M302-2 123456788
IC-M302-3 123456787
IC-M302-4 123456786
IC-M302-5 123456785
[CH]SEL [ENT]OK
  
```

- Select "Manual set" with [CH] then push [ENT]. After that, enter the desired 9-digit ID using the keypad.

```

***** Position REQ *****
----- Address ID -----
          9:7654321
[CH]↔ [ENT]OK
  
```

- ④ Rotate [CH] to select the desired pre-programmed calling frequency, or "Manual set" then push [ENT].
 - 2177 kHz should be used for ship-to-ship calls.
 - ✓ When the pre-programmed traffic frequency is selected, go to step ⑥.

```

***** Position REQ *****
----- Call frequency -----
#Manual set
T: 2345.0kHz IC-M302-1
R: 2345.0kHz
T: 2177.0kHz SHIP
R: 2177.0kHz
[CH]SEL [ENT]OK
  
```

- ⑤ Enter the desired transmit and receive call frequency using the keypad, then push [ENT].

```

***** Position REQ *****
----- Call frequency -----
TX: 2345.0kHz
RX: 2345.0kHz
[CH]SEL [ENT]OK
  
```

- ⑥ The calling stand-by screen is displayed as follows. Verify the calling information then hold down [CANCEL/CALL] for 1 second to transmit the position request call.
 - Hold down [ENT] for 1 second to store the calling information into the TX memory as described in pages 23 and 45, if desired.

```

***** Position REQ *****
----- Call -----
To:987654321
Call Freq:TX 2345.0kHz
RX 2345.0kHz
[CALL]Call [ENT]Write-Menu
  
```

- ⑦ After sending the call, the transceiver waits for the acknowledgement.

```

Position REQ
< Wait for ACK >
RX
  2.345.0 J2B
GPS Lat 34°34'N
SP Lon135°34'E
12:34
[FREQ]Exit
  
```

- ⑧ When receiving the acknowledgement, the display shows the ship's position as follows.

```

*****
* Position ACK *
* IC-M302 *
* Lat 34°34.343N *
* Lon 134°34.343E *
*****
[FREQ]Exit
  
```

NOTE:

The seconds digits may not be displayed depending on the called station's system.

- ⑨ Push [ENT] to return to DSC watch mode.

When no acknowledgement is received:

- ① Wait for 5 minutes, then call again on the same or a different frequency.
- ② If no acknowledgement is received after a 2nd call, wait for at least 15 minutes before repeating the call.

■ Test call

Testing on the exclusive DSC distress and safety calling frequencies (such as 2187.5 kHz) should be avoided as much as possible by using other methods. When testing on the distress/safety frequency is unavoidable, it should be indicated that these are test transmissions.

Normally the test call would require no further communications between the two stations involved.

- ① Push [MODE SET] to select the DSC menu.
- ② Rotate [CH] to select "Test" call, then push [ENT].
- ③ Select the desired coast station code, then push [ENT].
 - Use [CH] to select the coast station code when pre-programmed.

```
***** Test *****
----- Address ID -----
#Manual set
Port ICOM 001234567
Port ABC 001234566
Port M802 001234565

[CH]SEL [ENT]OK
```

- When "Manual set" is selected, enter the desired code (last 7 digits only) using the keypad.
- The first 2 digits "00 (double zero)" are fixed for the coast station code.

```
***** Test *****
----- Address ID -----

00754321

[CH]↔ [ENT]OK
```

- ④ Select the desired call frequency, then push [ENT].
 - Use [CH] to select one of the desired distress/safety frequencies.

```
***** Test *****
----- Call frequency -----
#Manual set
2187.5kHz
4207.5kHz
6312.0kHz
8414.5kHz
12577.0kHz
16804.5kHz

[CH]SEL [ENT]OK
```

- When "Manual set" is selected, enter the desired transmit and receive frequencies using the keypad.

```
***** Test *****
----- Call frequency -----

TX: 2187.5kHz
RX: 2187.5kHz

[CH]SEL [ENT]OK
```

- ⑤ The calling stand-by screen is displayed as follows, verify the calling information then hold down [CANCEL/CALL] for 1 second to transmit the test call.

```
***** Test *****
----- Call -----
To:007654321
Call Freq:TX 2187.5kHz
RX 2187.5kHz

[CALL]Call
```

- ⑥ After sending a call, the transceiver waits for an acknowledgement.

```
Test
< Wait for ACK >
RX 2.187.5 J2B
GPS Lat 34°34'N
SP Lon135°34'E
12:34

[FREQ]Exit
```

- ⑦ When receiving an acknowledgement, the display shows the received ID code, or ID name, if programmed.

```
*****
* Test ACK *
* ABC Port *
*****

[FREQ]Exit
```

■ To receive a DSC call

The independent built-in DSC receiver circuit in the IC-M802 scans all distress/safety frequencies, therefore, the “distress,” “urgency” and “safety” calls on those frequencies can be decoded at all times.

However, “routine,” “ships business,” “position request” and “group” calls on the other frequencies are received via the transceiver’s receiver circuit. Therefore, the transceiver must set to DSC watch mode to decode these calls.

◇ When receiving a DSC call

One of the following actions should be performed when a DSC call is received depending on the received DSC format (or category):

- Wait for a voice transmission on the traffic frequency.
- Transmit an acknowledgement with DSC or voice.

◇ Display example and operation

• Monitoring the traffic frequency

Monitor the communication between the calling ship and a coast station, or the calling station transmission via voice on the traffic frequency.

- Emergency alarm sounds until pushing [CANCEL/ CALL], or short beeps sound, depending on the calling format or category.

• Transmit an acknowledgement

When the following DSC is received, an acknowledgement must be sent back to the calling station.

- Short beeps, or an emergency alarm sounds until pushing [CANCEL/ CALL], depending on the category.

```

*****
*   Distress RLY   *
* 123456789      *
*****

*****
*   Distress      *
* 123456789      *
*****

*****
*   Group         *
* ICOM M802      *
*****

*****
*   Geographic   *
* 123456789      *
*****

[FREQ]Exit [ENT]Traffic
    
```

```

*****
*   Individual   *
* ICOM M802      *
*****

*****
*   Position REQ *
* ICOM M802      *
*****

*****
*   Test         *
* ABC Port       *
*****

[FREQ]Exit [ENT]ACK
    
```

Received information

When receiving a DSC call, the received format specifier and its contents are memorized into the RX memory. Distress calls (including other calls with a distress category) are stored separately from other calls.

Up to 20 distress and up to 10 other categories of call can be memorized.

- ① In the DSC watch mode, push [RX CLAR] to open the received DSC memory select screen.
 - Or, push [MODE SET], rotate [CH] to select "RX memory" then push [ENT].
- ② Rotate [CH] to select the desired category from "Distress" and "Others" then push [ENT].
 - "<No data>" is displayed beside category when no received message is stored in the category.

```
***** RX memory *****
----- Select -----
▶Distress
  Others

[CH]SEL [ENT]OK
```

- ③ Rotate [CH] to select the desired DSC message.
 - "*" means the DSC messages have not been read.
 - "DTRS RLY" stands for distress relay.
 - **Distress memory screen**

```
***** RX memory *****
----- Select -----
▶*123456789      12:34
  111111111     23:45
  123123123     21:54

[CH]SEL [ENT]OK
```

• **Others memory screen**

```
***** RX memory *****
----- Select -----
▶*Individual    123456789
  *DTRS RLY     111111111
  Geographic    123123123
  Individual    123456788
  Individual    123456789

[CH]SEL [ENT]OK
```

- ④ Push [ENT] to display the contents.
 - Rotate [CH] to scroll text to see hidden lines information.

```
***** RX memory *****
----- Distress -----
Distress ID:123456789
Undesignated
Position:Lat 34° 34.343N
          Lon134° 34.343E
          UTC 12:34
Traffic:Radiotelephone
          TX 2182.0kHz
          RX 2182.0kHz
RX Freq:TX 2187.5kHz
          RX 2187.5kHz
[CE]DEL [FREQ]Cancel [ENT]OK
```

- ⑤ Push [MODE SET] to return to DSC watch mode.

Deleting a memory

- When the desired memory contents to be deleted are displayed as at right, hold down [CE] for 1 second.
 - After erasing, the receive memory select screen, as in step ③ above, is selected automatically.

```
***** RX memory *****
----- Distress -----
Distress ID:123456789
Undesignated
Position:Lat 34° 34.343N
          Lon134° 34.343E
          UTC 12:34
Traffic:Radiotelephone
          TX 2182.0kHz
          RX 2182.0kHz
RX Freq:TX 2187.5kHz
          RX 2187.5kHz
[CE]DEL [FREQ]Cancel [ENT]OK
```

Position request call

- ① When "Position REQ" is displayed, as shown below, push [ENT].

```
*****
*      Position REQ      *
*      ICOM M802        *
*****
[FREQ]Exit [ENT]ACK
```

Calling station's name appears when the same ID is preprogrammed.

- ② Push [ENT] to display the call contents for acknowledgement preparation.

```
***** RX memory *****
----- Position REQ -----
From: ICOM M802
RX Freq: TX 12345.0kHz
          RX 12345.0kHz
[FREQ]Cancel [ENT]ACK
```

- ③ Verify your position and time, then push [ENT].
- When the position or time requires a change, use the keypad and [CH] for settings.
 - [CH] moves the cursor.

```
***** Position ACK *****
--- Position & time ---
Latitude  34° 34.343N
Longitude 104° 34.343E
          UTC 12:34
[CE]Null [CH]↔ [ENT]OK
```

- ④ Hold down [CANCEL/CALL] 1 second to transmit the Position request acknowledgement.
- Returns to DSC watch mode after the transmission, automatically.

```
***** Position ACK *****
----- Call -----
To: ICOM M802
Position: Lat 34° 34.343N
          Lon 104° 34.343E
          UTC 12:34
Call Freq: TX 12345.0kHz
          RX 12345.0kHz
[CALL]Call
```

Distress call

- ① When receiving a distress call, an emergency alarm sounds and the display below appears.

```
*****
*      Distress        *
*      123456789      *
*****
[FREQ]Exit [ENT]Traffic
```

- ② Push [CANCEL/CALL] to stop the alarm.
- One distress call sequence is sent 5 times repeatedly within approximately 30 seconds. The emergency alarm sounds at each reception.
- ③ Push [ENT] to set the transceiver to the distress phone frequency, then monitor the communication from the coast station to the ship in distress.
- ④ Select the received distress call memory channel to check the position of the ship in distress.
- ➔ Push [FREQ/CH] then [RX CLAR] to select "RX memory" screen.
 - ➔ Select "Distress" with [CH] then push [ENT].
 - ➔ Push [ENT] again.
 - The received distress call memory is displayed at the top line with "*" symbol.
 - When the ship is close to you, communication should be monitored continuously.
 - The traffic frequency is monitored even when the memory contents are displayed.

```

DISTRESS
RX <Traffic> J3E
2.182.0
GPS Lat 34° 34' N
SP Lon 104° 34' E
          12:34
[FREQ]Exit
```

```
***** RX memory *****
----- Distress -----
Distress ID: 123456789
Undesignated
Position: Lat 34° 34.343N
          Lon 104° 34.343E
          UTC 12:34
Traffic: RadiotelePhone
          TX 2182.0kHz
          RX 2182.0kHz
RX Freq: TX 2187.5kHz
          RX 2187.5kHz
[CE]DEL [FREQ]Cancel [ENT]OK
```

■ Distress relay call

- ① When receiving a distress relay call, an emergency alarm sounds and the display below appears.

```
*****
*      Distress RLY      *
*      001234567        *
*****
[FREQ]Exit [ENT]Traffic
```

- ② Push any key to stop the alarm.
 ③ Push [ENT] to set the transceiver to the distress phone frequency, then monitor the communication from the coast station to the ship in distress.

```

DISTRESS
RX < Traffic > J3E
2.182.0
GPS Lat 34° 34' N
SP Lon135° 34' E
12:34
[FREQ]Exit
```

- ④ Select the received distress call memory channel to check the position of the ship in distress.
- Push [FREQ/CH] then [RX CLAR] to select "RX memory" screen.
 - Select "Others" with [CH] then push [ENT].
 - Push [ENT] again.
 - The received distress relay call memory (DTRS RLY) is displayed at the top line with "*" symbol.
 - When the ship is close to you, communication should be monitored continuously.
 - The traffic frequency is monitored even when the memory contents is displayed.

```
***** RX memory *****
----- Distress RLY -----
From:001234567
Distress ID:123456789
To all ships
Undesignated
Position:Lat 34° 34.343N
Lon134° 34.343W
UTC 12:34
Traffic:RadiotelePhone
TX 2182.0kHz
RX 2182.0kHz
RX Freq:TX 2187.5kHz
RX 2187.5kHz
[CE]DEL [FREQ]Cancel [ENT]OK
```

◇ Distress relay acknowledgement call operation

The distress relay acknowledgement call can be made only when distress relay call is received.

- ① After receiving a distress relay call, push [FREQ/CH] to return to DSC watch mode.
 ② Push [MODE SET] to select the DSC menu.
 ③ Rotate [CH] to select "Distress RLY ACK" then push [ENT].
- "Distress RLY ACK" can be selected only when distress relay call is received.

```
***** DSC MENU *****
----- Select -----
Position
Individual
Group
GeograPhical
Position REQ
Distress
*Distress RLY ACK
Test
RX memory
TX memory
Set up
Exit
[CH]SEL [ENT]OK
```

- ④ Rotate [CH] to select the distress call to be replied, then push [ENT].

```
*** Distress RLY ACK ***
----- Select -----
*001234567
007654321
[CH]SEL [ENT]OK
```

- ⑤ The calling stand-by screen is displayed as follows. Verify the calling information, then hold down [CALL] for 1 second to transmit the call.

```
*** Distress RLY ACK ***
----- Call -----
To:001234567
Distress ID:123456789
Undesignated
Position:Lat 34° 34.343N
Lon134° 34.343W
UTC 12:34
Traffic:RadiotelePhone
TX 2182.0kHz
RX 2182.0kHz
RX Freq:TX 2187.5kHz
RX 2187.5kHz
[CALL]Call
```

Individual call

When receiving an Individual call, beeps may sound (or the emergency alarm depending on the category) and the display below appears.

```
*****
*      Individual      *
*      ICOM M802      *
*****
[FREQ]Exit [ENT]ACK
```

Calling station's name appears when the same ID is preprogrammed.

You must send back an acknowledgement to the calling station in such cases.

- When "Individual" is displayed as above, push [ENT] to display the calling contents.
 - The received call is selected in RX memory.
 - Rotate [CH] to scroll text to see hidden lines information.

```
***** RX memory *****
----- Individual -----
Category:Routine
From:ICOM M802
Traffic:RadiotelePhone
TX 2345.0kHz
RX 2345.0kHz
RX Freq:TX 12345.0kHz
RX 12345.0kHz
[DEL] [FREQ]Cancel [ENT]ACK
```

- Push [ENT] for acknowledgement call preparation.

- Rotate [CH] to select that you can comply to the call or not from "Able" and "Unable," then push [ENT].
 - When "Able" is selected, go to step 5.

```
***** Individual ACK *****
----- Comply -----
[Able]
[Unable]
[DEL] [FREQ]Cancel [ENT]ACK
```

- When "Unable" is selected in step 3, rotate [CH] to select the desired reason, then push [ENT].

- Push [CANCEL/CALL] for 1 second to transmit the Individual acknowledgement.
 - When "Able" is selected in step 3.

```
**** Individual ACK ****
----- Call -----
Category:Routine
To:ICOM M802
Traffic:RadiotelePhone
TX 2345.0kHz
RX 2345.0kHz
Call Freq:TX 12345.0kHz
RX 12345.0kHz
[CALL]Call
```

- When "Unable" is selected in step 3.

```
**** Individual ACK ****
----- Call -----
Category:Routine
To:ICOM M802
Unable to comply
Reason:
Operator unavailable
Call Freq:TX 12345.0kHz
RX 12345.0kHz
[CALL]Call
```

- After the transmission—
 - When "Able" is selected in step 3, the transceiver selects the specified traffic frequency.

```
< Traffic >
RX      2.345.0 J3E
        GPS Lat 34°34'N
        SP   Lon135°34'E
        12:34
[FREQ]Exit
```

- When "Unable" is selected in step 3, the transceiver selects the DSC watch mode screen.

■ Group call

① When receiving an Group call, beeps may sound and “Group” is displayed, as shown below.

- Push [CANCEL/CALL] to stop the alarm when an emergency or urgency group call is received.

```
*****
*           Group           *
*       ICOM M802         *
*****
[FREQ]Exit [ENT]Traffic
```

Calling station's name appear when the same ID is preprogrammed.

② Push [ENT] to listen to the traffic frequency for an announcement from the calling ship (mother ship in your group).

```
< Traffic >
RX      12.345.0      J3E
        GPS Lat 34° 34'N
        Lon134° 34'E
        12:34
[FREQ]Exit
```

- ③ Communicate via the microphone with the ship when the calling ship requires such.
- ④ Push [FREQ/CH] to return to DSC watch mode.

■ Geographical area call

NOTE: The IC-M802 will not function for the geographical call when:

- Your position is out of the specified area.
- A GPS receiver is not connected to [GPS] and you haven't input the position information manually.

① When receiving a geographical area call and your position is in the specified area, “Geographic” is displayed, as shown below.

- Push [CANCEL/CALL] to stop the emergency alarm when the call is sent in distress.

```
*****
*           Geographic      *
*       123456789         *
*****
[FREQ]Exit [ENT]Traffic
```

② Push [ENT] to select the traffic frequency, and listen for an announcement from the calling station.

- Rotate [CH] to scroll text to see the hidden lines information.

```
< Traffic >
RX      12.345.0      J3E
        GPS Lat 34° 34'N
        Lon134° 34'E
        12:34
[FREQ]Exit
```

③ Push [FREQ/CH] to return to DSC watch mode.

■ Test call

① When receiving an Test call from a coast radio station, beeps may sound and “Test” is displayed, as shown below.

```
*****
*           Test           *
*       ABC Port         *
*****
[FREQ]Exit [ENT]ACK
```

② Push [ENT] to display the calling contents.

- The received call is memorized in RX memory.

```
***** RX memory *****
----- Test -----
Category: Safety
From: ABC Port
RX Freq: TX 2187.5kHz
        RX 2187.5kHz
[FREQ]Cancel [ENT]ACK
```

③ Push [ENT] for acknowledgement call preparation.

④ The transceiver shows calling stand-by screen, as shown below.

Verify the calling information then hold down [CANCEL/CALL] for 1 second to transmit the Test call acknowledgement.

```
***** Test ACK *****
----- Call -----
Category: Safety
To: ABC Port
Call Freq: TX 2187.5kHz
        RX 2187.5kHz
[CALL]Call
```

Memory description

The IC-M802 has several kinds of memories as follows:

- Address and group ID code memories (p. 46)
- Call, traffic and scan frequency memories. (p. 47)
- DSC transmission memory (described in this section)
- Received message memory (p. 40)

10 DSC transmission memory channels allow you to set often used format specifiers and contents such as for routine calls, group calls, etc.

Memory writing

- ① During DSC watch mode, select the desired format category (except distress and test), and set the message, traffic and call frequencies until the call stand-by screen is displayed as described in the CALL PROCEDURE section (pp. 21–37).
- ② Hold down [ENT] for 1 second to select the TX memory write mode.
- ③ Rotate [CH] to select the desired memory channel.
- ④ Hold down [ENT] for 1 second again to store the condition into the selected memory channel.
 - The set DSC format and calling station ID/name appear.

```

----- TX memory write -----
▶0: Individual 987654321
1:
2:
3:
4:
5:
6:
7:
8:
9:
[CALL]SEL [ENT]Write
    
```

```

----- TX memory write -----
▶0: Individual 987654321
1:
2:
3:
4:
5:
6:
7:
8:
9:
[CALL]SEL [ENT]OK
    
```

- ⑤ Push [ENT] to return to the calling stand-by condition, or push [MODE SET] to return to DSC watch mode.

Memory reading/transmitting/deleting

- ① Push [DSC] to select DSC watch mode, if necessary.
- ② Push [TX TXF] to enter the DSC transmit memory screen.
 - Or, push [MODE SET], rotate [CH] to select "TX memory" then push [ENT], also selects the transmit memory screen.
- ③ Rotate [CH] to select the selected memory channel to be read.
- ④ Push [ENT] to display the memory contents.

```

***** TX memory *****
----- Select -----
▶0: Individual 987654321
1:
2:
3:
4:
5:
6:
7:
8:
9:
[CALL]SEL [ENT]OK
    
```

```

***** TX memory *****
----- Individual -----
Category:Distress
To:987654321
Traffic:RadiotelePhone
TX 2134.0kHz
RX 2134.0kHz
Call Freq:TX 2187.5kHz
RX 2187.5kHz
[CALL]Call [CE]DEL
    
```

- ⑤ Operate as follows:
 - **When reading the memory contents only;**
 - Push [MODE SET] to return to DSC watch mode.
 - **When transmitting the memory contents;**
 - Hold down [CANCEL/CALL] for 1 second.
 - **When clearing the memory contents;**
 - Hold down [CE] for 1 second.

10 DSC MENU OPERATION

■ General

Up to 100 ID codes with frequency and name can be programmed in MENU mode for easy recall during DSC call setting.

In addition, the following settings/operation are available in DSC setup menu.

- Manual position/time setting (p. 16)
- Self-ID (MMSI code) indication (described in this section)

■ ID input

A total of 100 ID codes can be programmed as “Address ID” (for ships and coast stations) and “Group ID” (for group stations). A pair of frequencies (both transmit and receive) and ID name are also programmed together with the ID code which are used as call frequencies when using the ID code.

◇ SETTING PROCEDURES:

- ① During DSC menu indication, rotate [CH] to select “Set up” then push [ENT] to select setup menu.
 - The select screen is displayed as below.

```
***** Set up *****
----- Select -----
▶Address ID
  Group ID
  Call frequency
  Traffic frequency
  Scan frequency
  MMSI check
[CH]SEL [ENT]OK
```

- ② Rotate [CH] to select the “Address ID” or “Group ID,” then push [ENT].
 - The address/group ID list screen is displayed.

```
***** Set up *****
----- Address ID -----
***** Set up *****
----- Group ID -----
▶<add>
[CH]SEL [FREQ]Cancel [ENT]OK
```

When the memory is full:

“Memory full” is displayed beside “<add>” indication when 100 ID codes have been programmed.

Delete any unnecessary IDs in such cases (see p. 48 for deleting).

- ③ Rotate [CH] to select “<add>” then push [ENT].
 - The address/group ID setup screen is displayed.

```
***** Set up *****
----- Address ID -----
***** Set up *****
----- Group ID -----
Name: [sun]
ID: 0
TX: . . . . . kHz
RX: . . . . . kHz
[CH]SEL [FREQ]Cancel [ENT]OK
```

- ④ Push the numeral keys to input the desired 10-digit ID name, 9-digit code and both transmit and receive frequencies, then push [ENT].

- Rotate [CH] to move the cursor.
- When entering group code, enter “0 (zero)” for the first digit.
- The frequencies entered should be within the marine frequency ranges as follows.

1.6– 2.9999 MHz	4.0– 4.9999 MHz
6.0– 6.9999 MHz	8.0– 8.9999 MHz
12.0–13.9999 MHz	16.0–17.9999 MHz
18.0–19.9999 MHz	22.0–22.9999 MHz
25.0–27.5000 MHz	

```
***** Set up *****
----- Address ID -----
***** Set up *****
----- Group ID -----
Name: ICOM M802_
ID: 012345678
TX: _2345_ kHz
RX: _2345_ kHz
[CH]SEL [FREQ]Cancel [ENT]OK
```

- ⑤ Push [ENT] to program the contents into the address or group ID.

- Returns to the address/group ID list screen automatically.
- The ID list is displayed in alphabetical order for ID name, so [CH] rotation may be necessary for the programmed ID confirmation.

```
***** Set up *****
----- Address ID -----
***** Set up *****
----- Group ID -----
▶<add>
ICOM M802 012345678
[CH]SEL [FREQ]Cancel [ENT]OK
```

- ⑥ Push [MODE SET] to return to DSC watch mode, or push [FREQ/CH] to return to the select screen.

Frequency input

A total of 50 frequency pairs can be programmed as “Call frequency,” “Traffic frequency” or “Scan frequency.” The frequency usage and frequency name are also programmed together with the frequency.

NOTE: Up to 6 pairs of frequencies only can be assigned as a scan frequency. They are scanned during DSC watch mode only. (Different from the distress/safety frequencies.)

SETTING PROCEDURES:

- ① During DSC menu indication, rotate [CH] to select “Set up” then push [ENT] to select setup menu.
 - The select screen is displayed.
- ② Rotate [CH] to select the “Call frequency” “Traffic frequency” or “Scan frequency” then push [ENT].
 - The call/traffic/scan frequency list screen is displayed.

```

***** Set up *****
---- Call fr9eueency ----

***** Set up *****
-- Traffic fr9eueency ---

***** Set up *****
---- Scan fr9eueency ----
▶<add>

CHSEL FREQ Cancel ENT OK
    
```

When the memory is full:

“Memory full” is displayed beside “<add>” indication when a total of 50 pairs of frequencies (6 pairs for scan frequency) have been programmed. Delete any unnecessary frequency in such cases (see p. 48 for deleting).

- ③ Rotate [CH] to select “<add>” then push [ENT].
 - The call/traffic/scan frequency setup screen is displayed.

```

***** Set up *****
---- Call fr9eueency ----

***** Set up *****
-- Traffic fr9eueency ---

***** Set up *****
---- Scan fr9eueency ----

Comment:
TX: : kHz
RX: : kHz

CHSEL FREQ Cancel ENT OK
    
```

- ④ Push the numeral keys to input the desired 10-character frequency name, and both transmit and receive frequencies, then push [ENT].
 - Rotate [CH] to move the cursor.
 - The frequencies entered should be within the marine frequency ranges as follows.

1.6– 2.9999 MHz	4.0– 4.9999 MHz
6.0– 6.9999 MHz	8.0– 8.9999 MHz
12.0–13.9999 MHz	16.0–17.9999 MHz
18.0–19.9999 MHz	22.0–22.9999 MHz
25.0–27.5000 MHz	

```

***** Set up *****
---- Call fr9eueency ----

***** Set up *****
-- Traffic fr9eueency ---

***** Set up *****
---- Scan fr9eueency ----

Comment:ICOM_Group
TX: 4567.0kHz
RX: 4567.0kHz

CHSEL FREQ Cancel ENT OK
    
```

- ⑤ Push [ENT] to program the contents into a call, traffic or scan frequency.
 - Returns to the call/traffic/scan frequency list screen.
 - The programmed frequency is displayed at the bottom line, so [CH] rotation is necessary for the programmed frequency confirmation.

```

***** Set up *****
---- Call fr9eueency ----

***** Set up *****
-- Traffic fr9eueency ---

***** Set up *****
---- Scan fr9eueency ----
▶<add>

T: 4567.0kHz ICOM Group
R: 4567.0kHz

CHSEL FREQ Cancel ENT OK
    
```

- ⑥ Push [MODE SET] to return to DSC watch mode, or push [FREQ/CH] to return to the select screen.

■ Verifying self-ID

- ➔ During setup select menu indication, rotate [CH] to select "MMSI check" then push [ENT] to display the programmed MMSI ID (self-ID).
- ➔ Push [DSC] to select DSC watch mode.
- ➔ Push [MODE SET] to select DSC menu.
- ➔ Rotate [CH] to select "Set up" then push [ENT].
- Push [MODE SET] to return to DSC watch mode, or push [FREQ/CH] to return to the select screen.

```

***** Set up *****
----- MMSI check -----

ID:123456789

[FREQ]Cancel [ENT]OK
    
```

■ Memory reading/deleting

- ① During setup select menu indication, rotate [CH] to select the desired memory item then push [ENT].
 - Push [DSC] to select DSC watch mode.
 - Push [MODE SET] to select DSC menu.
 - Rotate [CH] to select "Set up" then push [ENT].
- ② Rotate [CH] to select the desired memory, then push [ENT].

- ③ Operate as follows:
 - ➔ **When reading the memory contents only;**
 - Push [ENT] to return to the appropriate memory list screen.
 - ➔ **When deleting the memory contents;**
 - Hold down [CE] for 1 second.
 - After deleting, the appropriate memory list screen is displayed automatically.

```

***** Set up *****
----- Address ID -----

***** Set up *****
----- Group ID -----

Name:ICOM M802
ID:012345678
TX: 2345.0kHz
RX: 2345.0kHz

[CE]DEL [ENT]OK
    
```

```

***** Set up *****
----- Call fr9eueency -----

***** Set up *****
----- Traffic fr9eueency -----

***** Set up *****
----- Scan fr9eueency -----

Comment:ICOM Group
TX: 4567.0kHz
RX: 4567.0kHz

[CE]DEL [ENT]OK
    
```

■ General

The IC-M802 is ready for HF e-mail operation— up to 160 e-mail frequency channels and a connecting terminal for an e-mail modem are available.

Independent e-mail frequencies with operating mode and filter settings can be selected with a push of a button or group/channel selector rotation for simple operation.

NOTE: For e-mail operation, you MUST make a contract with an HF e-mail provider and purchase an e-mail modem from the provider or your dealer. E-mail frequencies may need to be programmed by your dealer depending on your modem selection. Ask your dealer for more details.

■ Operation

- ① Connect your PC via an e-mail modem to [AF/MOD] on the IC-M802 main unit front panel.
 - See page 55 for connection details.
- ② Start up the e-mail application.
 - Set up the necessary information given from your provider for e-mail operation in advance.
- ③ Push [e-mail] then rotate [GRP] and [CH] to select the desired e-mail channel.

NOTE: E-mail mode cannot be accessed from DSC watching mode. Select regular voice operation mode by pushing [DSC] in advance.

- Pushing [▲]/[▼] on the microphone also selects the channel.
- [GRP] rotation changes in 20-channel increments.
- Selectable e-mail frequencies may differ according to your provider.

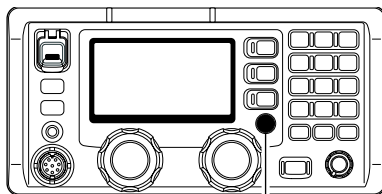

[e-mail]

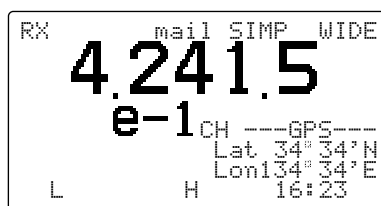

12 SET MODE

■ Quick set mode

◇ Entering quick set mode

- ① Push [F] then [MODE SET] to enter quick set mode.
 - Select voice or e-mail operation mode in advance.
- ② Rotate [GRP] to select the desired item.
- ③ Rotate [CH] to set the values or conditions for the selected item.
- ④ Push any key to exit quick set mode.

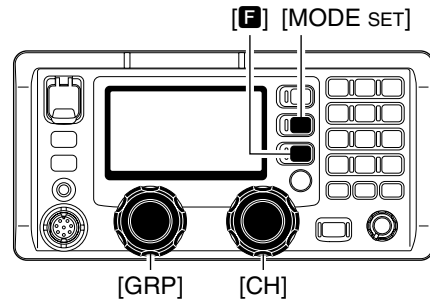

◇ Quick set mode items

Noise blanker level

This item adjusts the noise blanker level to protect a signal from various pulse-type noises from 1 to 10.
(default: 5)

The set level is effective when the noise blanker is activated.



Squelch level

This item adjusts the squelch threshold level from 1 to 100.
(default: 30)

When the squelch is activated, signals stronger than this set level only are received.

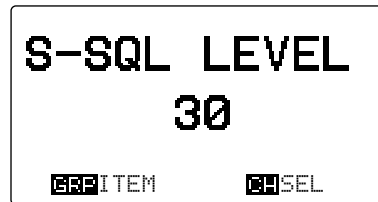

Dimmer

This item sets the LCD backlight brightness for dimmer selection from 0 (dark) to 10 (bright).

By pushing [F] then [0 DIM], the set brightness is selected to provide easy visibility during night time operation, etc.
(default: 6)

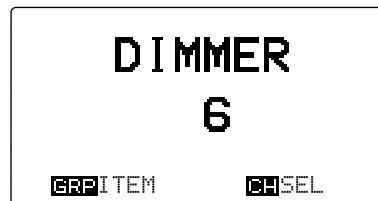

LCD contrast

This item sets the LCD contrast from 1 to 10.
(default: 7)



Filter selection

✓ This item appears when e-mail mode is selected before entering quick set mode.

Selects the IF filter passband width for independent e-mail channel operation from WIDE (2.8 kHz; default), MIDDLE (2.4 kHz) and NARROW (500 Hz).



Initial set mode

Initial set mode operation is used for programming infrequently changed values, conditions or functions.

◇ Entering set mode

- ① Turn OFF the power, if the transceiver is powered ON.
- ② While pushing [MODE SET], push [POWER] to turn ON the power to enter initial set mode.
- ③ Rotate [GRP] to select the desired item.
- ④ Rotate [CH] to set the values or conditions for the selected item.
- ⑤ Turn the power OFF and ON again to exit set mode.

NOTE: Selection of some of the set mode items described here are not available on some transceiver versions.

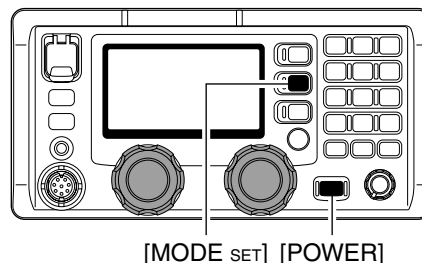

◇ Initial set mode items

Number of user channels

This item sets the number of user channels. Up to 160 channels can be set. (default: 160)

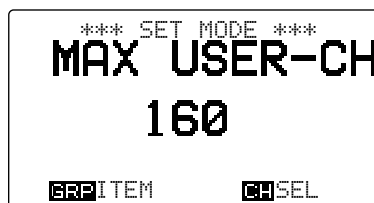

FSK ITU channel selection

This item sets the capability of the ITU channels for FSK from ON or OFF. This item will not appear when ITU channels are inhibited. (default: OFF)

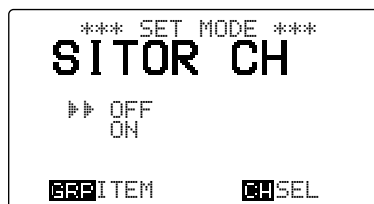

External antenna tuner type

This item selects the connected Icom antenna tuner type from AT-140, AT-130/E, AT-120/E and AH-3.

- AT-140 : AT-140 is connected. (default)
- AT-130/E : AT-130/E is connected.
- AT-120/E : AT-120/E is connected.
- AH-3 : AH-3 is connected.

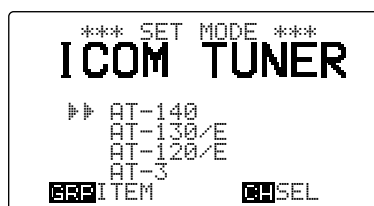

Automatic tune

When an optional automatic antenna tuner is connected, tuning can be started automatically without pushing [TUNE THRU], for instant operation.

If manual tuning is required, this automatic operation can be deactivated. (default: OFF)



◇ Initial set mode items (continued)

Scan type

This item selects one of the following scan functions.

Programmed scan searches signals within the frequency range and activates slowly while squelch is open and fast while squelch is closed.

Channel scan and channel resume scan searches 20 channels around a user selected channel, or searches all ITU channels in the band when an ITU channel is selected. (default: CH SCAN)

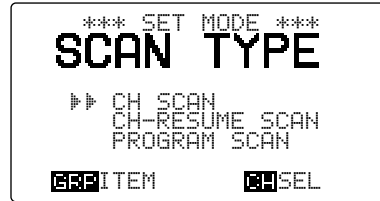

Scan speed

This item adjusts the scan speed (rate at which channels are searched). The scan speed can be set from 1 to 10 with "1" being the fastest and "10" being the slowest. (default: 4)



Display type

The upper half of the display can be set to display a programmable channel name or a receive frequency according to your needs. (default: CH-NAME)



J2B filter

Select the IF filter passband width for J2B mode operation from wide, mid and narrow.

- WIDE : 2.4 kHz
- MIDDLE : 1.0 kHz
- NARROW : 500 Hz (default)

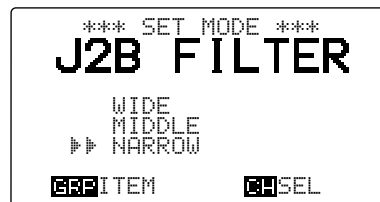

F1B filter

Select the IF filter passband width for F1B mode operation from normal and narrow.

- WIDE : 1.0 kHz
- NARROW : 500 Hz (default)



FSK tone frequency

Several mark frequencies are used for FSK operation. This item selects an FSK mark frequency for almost any FSK system from 1200 Hz, 1275 Hz, 1487.5 Hz, 1615 Hz, 2100 Hz and 2125 Hz. (default: 1615Hz)



◇ Initial set mode items (continued)

FSK shift frequency

Several shift frequencies are used for FSK operation. This item selects an FSK shift frequency for almost any FSK system from 850 Hz, 425 Hz, 200 Hz and 170 Hz. (default: 170 Hz)



FSK polarity

Normal and reverse polarities are available for FSK operations. This item allows you to select one of these polarities.

- **NORMAL** : Key open=space; Key close=mark (default)
- **REVERSE** : Key open=mark; Key close=space

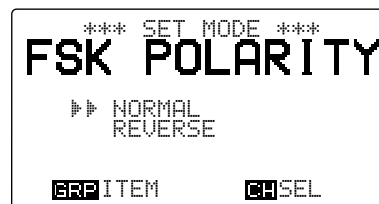

CW break-in function

The CW break-in function (in A1A mode) toggles transmit and receive with CW keying. Full break-in allows you to receive signals between transmitted keying pulses during CW transmission. Semi break-in allows you to mute receiving until keying stops with some delay time. (default: FULL)

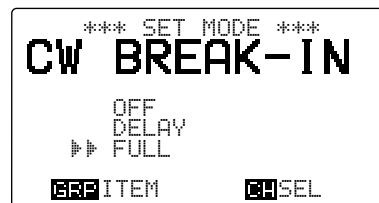

Microphone keys

This item activates/deactivates the keys on the HM-135 HAND MICROPHONE ([P], [▲] and [▼]). Refer below on how to program the [P] key. (default: ON)



[P] key function

This item assigns a function to the [P] key on the HM-135 HAND MICROPHONE to activate it the same as if making the key operation for [TUNE THRU], [MODE SET], [F]+[1 NB], [F]+[2 SQL], [F]+[3 SCAN], [F]+[4 SP*] or [F]+[5 AGC*]. (default: MODE)

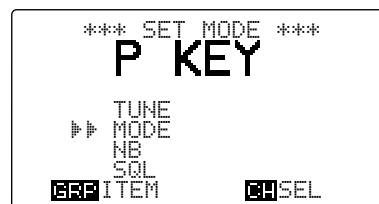

Voice squelch

This item turns the voice squelch function ON or OFF when operating in J3E and H3E modes. When the function is set to OFF, the squelch acts as an S-meter squelch for J3E and H3E modes. (default: ON)

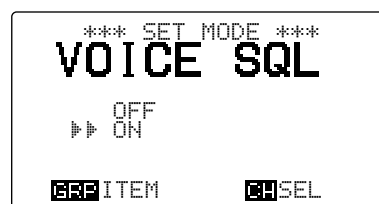

◇ Initial set mode items (continued)

REMOTE ID

This item selects the ID for the transceiver from 1 to 99.
(default: 08)

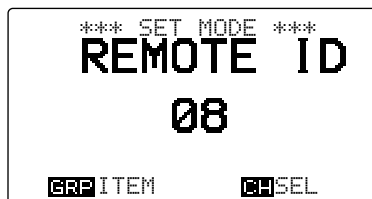

REMOTE connector interface

This item selects the interface format for [REMOTE] connector.
(default: NMEA)



Modulation input/output selection

This item selects the input/output terminal for signals to/from an external unit, such as an HF e-mail modem, TNC (Terminal Node Controller), etc.
(default: AF/MOD)



Position indication type

Select the position indicating type from simple and detail.

- SIMPLE : Hides second digits (default)
- DETAIL : Shows second digits

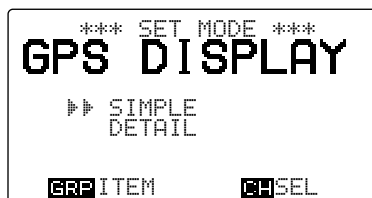

Offset time

Set the offset time between the UTC and local time within -12:00 to +12:00 in 10 minutes steps.
(default: 0:00)



■ Supplied accessories

The following accessories are supplied with IC-M802.

- ① Microphone (HM-135)..... 1
- ② External speaker (SP-24) 1
- ③ Mounting bracket kit for main unit..... 1 set
- ④ Mounting bracket kit for remote controller (MB-81)
..... 1 set
- ⑤ Mounting bracket kit for speaker (MB-82) ... 1 set
- ⑥ DC power cable 1
- ⑦ Microphone hanger kit 1 set
- ⑧ Cable tie set 1 set
- ⑨ Spare fuses (FGB 30 A)..... 1
- ⑩ Spare fuses (FGB 5 A) 2
- ⑪ Remote control cable 1
- ⑫ Tuner connector kit 1 set
- ⑬ Accessory connector (8-pin DIN) 1 set

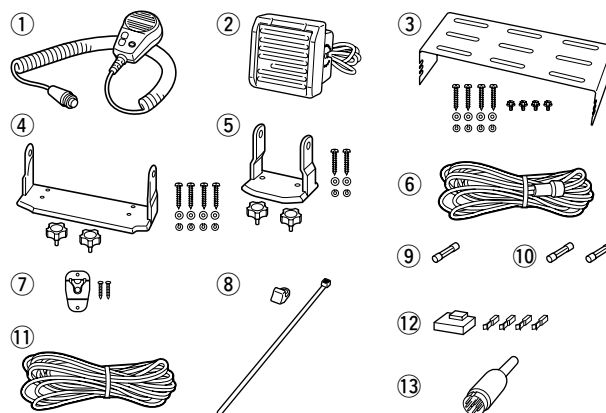

■ Front panel connections

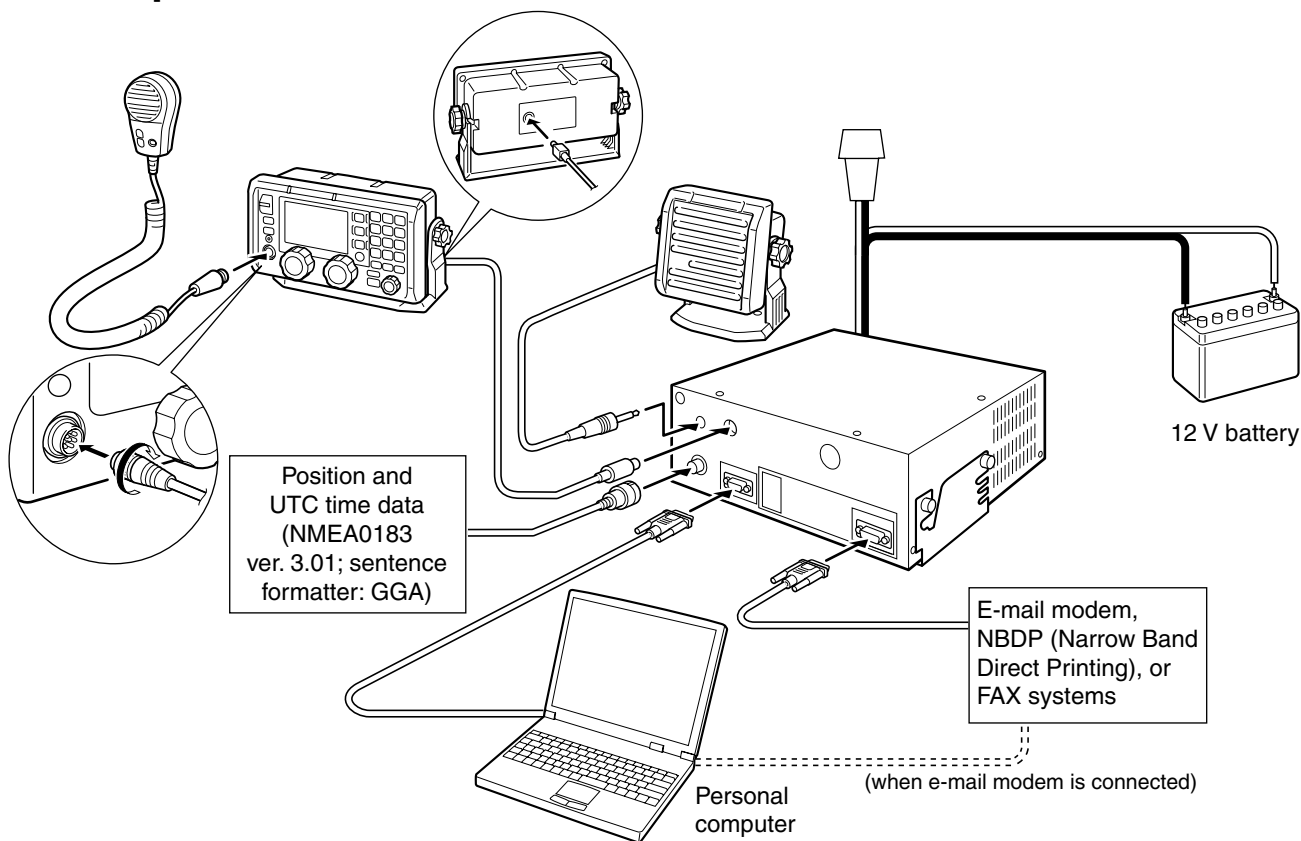

CAUTION: Any connected external unit, such as PC, e-mail modem, etc., must be properly grounded. We suggest using a wide copper strap. (p. 57)

➔ When a PC is connected, the PC being operated at any given time has priority.

➔ When a PC is connected, the controller not being operated is inhibited for a specified time after the PC is operated. This time can be programmed by your dealer. The default inhibit time is 5 seconds.

➔ When a PC is connected, operating the PC automatically updates settings on the controller.

■ Rear panel connections

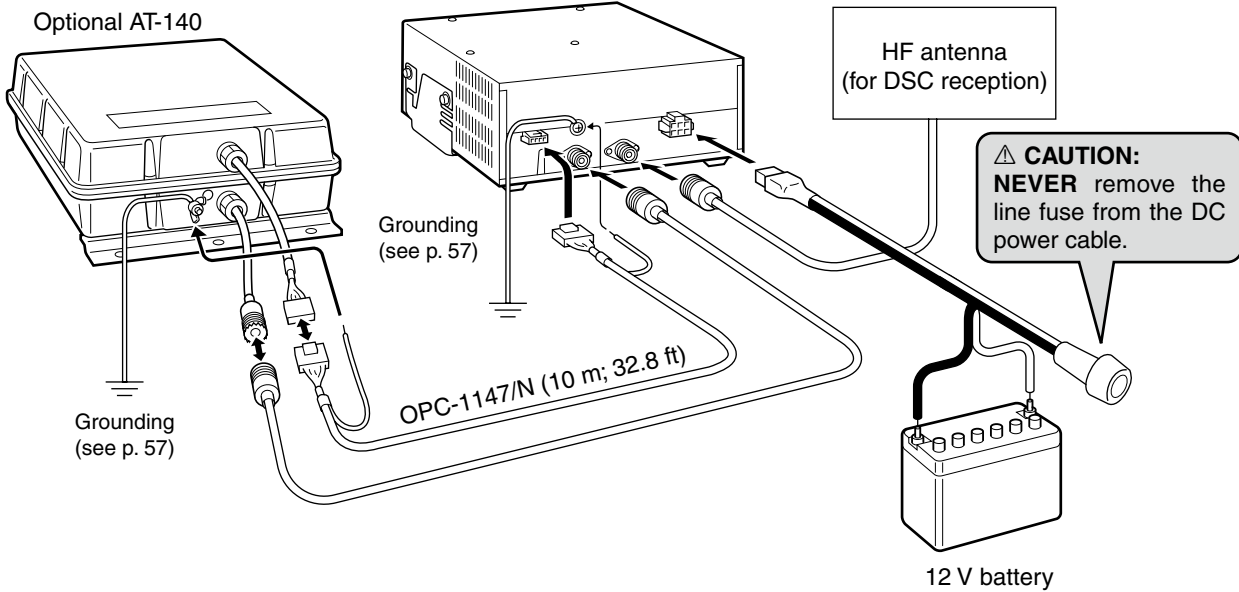

CAUTION:

- After connecting the antenna cable and tuner control cable, cover the connectors with a rubber vulcanizing tape, etc., as shown below, to prevent water seeping into the connector.

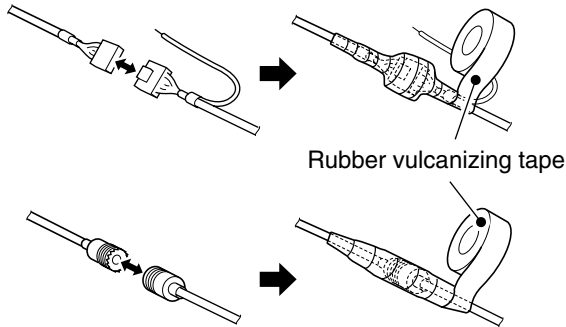

- **DO NOT** pull the antenna and control cable receptacles. This may cause cable disconnection (in the tuner unit), inside connector damaged or a bad connection.

- **CAUTION: NEVER** connect to a 24 V battery. This will damage the transceiver.

NOTE:

Disconnect the battery from the IC-M802 main unit, or charge the battery during anchor, otherwise the battery may be exhausted. The IC-M802 has a high-stability oven-heater type crystal oscillator, and when connected to the DC power socket directly, it keeps its temperature to at the specified level even if the transceiver power has turned OFF.

IMPORTANT! Antenna for DSC reception should be connected, otherwise no DSC call can be received.

✓ Use the supplied cable tie

To prevent an accidental cable disconnection, particularly for the external speaker and remote control cables, the supplied cable tie may be helpful.

- ① Install the cable tie (base) onto the IC-M802 main unit side panel, or desired place near the main unit.

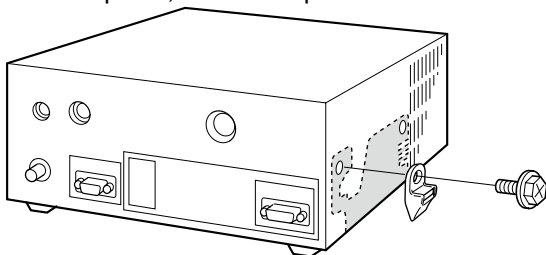

- ② Insert the cable tie (fastener), then fasten the cables.

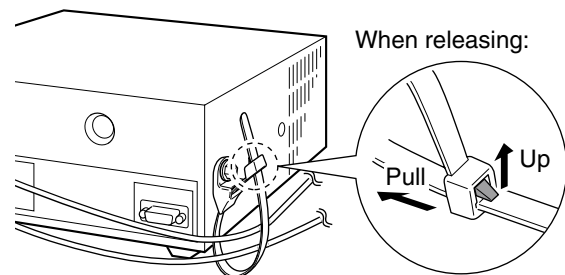

Ground connection

The transceiver and antenna tuner **MUST** have an adequate RF ground connection. Otherwise, the overall efficiency of the transceiver and antenna tuner installation will be reduced. Electrolysis, electrical shocks and interference from other equipment could also occur.

For best results, use 50 or 75 mm (2 or 3 inches) wide copper strap and make the connection as short as possible. Ground the transceiver and antenna tuner to one ground point, otherwise the voltage difference (in RF level) between 2 ground points may cause electrolysis.

WARNING— *When grounding to a metal hull*
 Use Zinc anodes to protect the hull from electrolysis.
 Ask your technical dealer, installer or refer to a technical book, etc., for RF grounding details.

CAUTION: NEVER connect the transceiver to a “positive-grounded ship,” otherwise the transceiver will not function.

Best ground points

- External ground plate
- Copper screen
- Copper foil

Acceptable ground point

- Stainless steel stanchion
- Through mast
- Through hull
- Metal water tank

Undesirable ground points

- Engine block
- Ship’s DC battery ground

Un-usable ground points

(These connections may cause an explosion or electrical shock.)

- Gas or electrical pipe
- Fuel tank or oil-catch pan

Ground system example

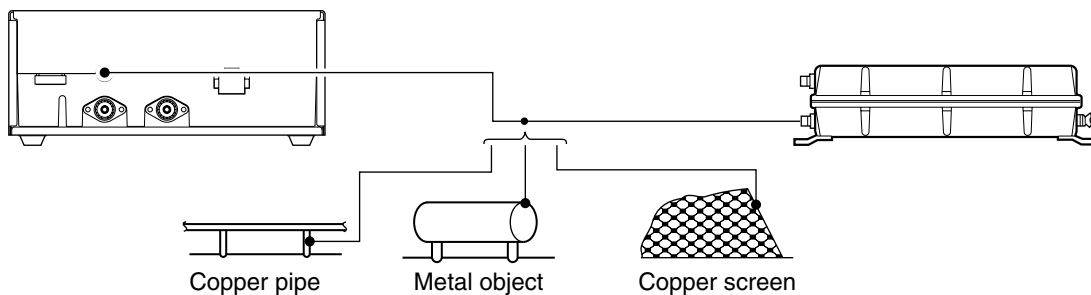

Power source

The transceiver requires a regulated DC power of 13.6 V and at least 30 A. There are 2 ways to supply power:

- Direct connection to a 12 V battery in your ship through the supplied DC power cable.

CAUTION: The supplied DC power cable **MUST** be used to provide power to the transceiver. **AVOID** exceeding the 3 m (10 ft.) length of the DC power cable. When it is necessary to make a run of over 3 m, use a #6 or similar gauge wire with line fuses, instead of the supplied DC power cable for a maximum of 6 m (20 ft.).

DC power cable connection

NOTE: Use terminals for the cable connection.

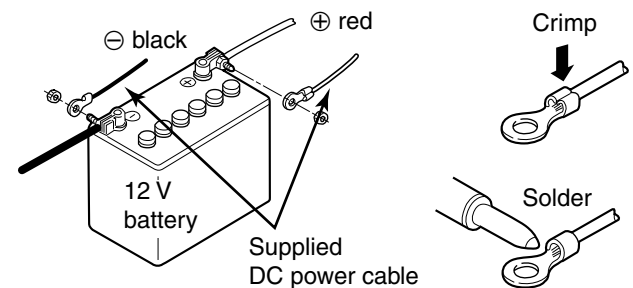

■ Antenna

Most stations operate with a whip or long wire (insulated backstay) antenna. However, these antennas cannot be connected directly to the transceiver since their impedance may not be matched with the transceiver antenna connector.

Even with a 50 Ω matched antenna, all marine bands may not be fully usable. The following antenna matcher or antenna tuner may be helpful for proper antenna installation.

⚠ WARNING: HIGH VOLTAGE!
NEVER touch the antenna element/wire while tuning or transmitting.

◇ MN-100/MN-100L ANTENNA MATCHERS

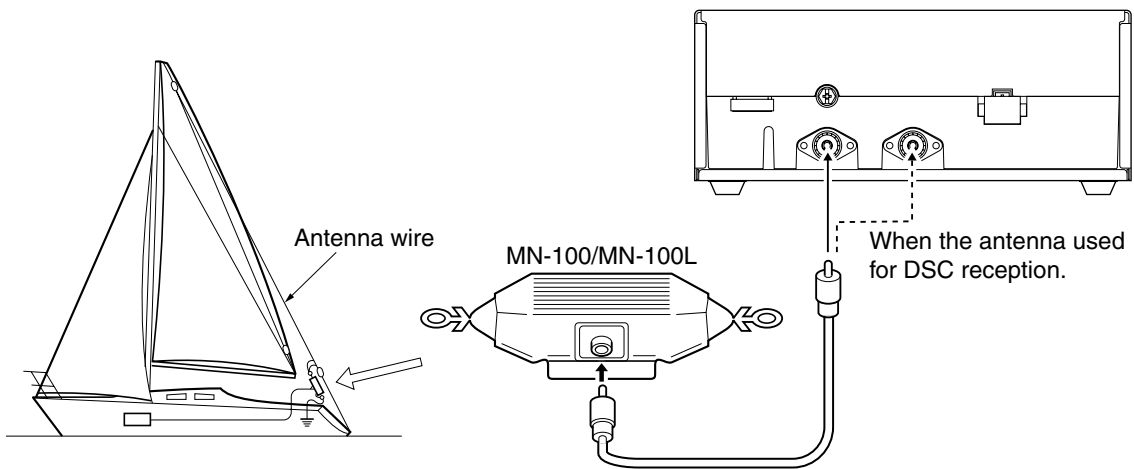

◇ AT-130/AT-130E AUTOMATIC ANTENNA TUNER

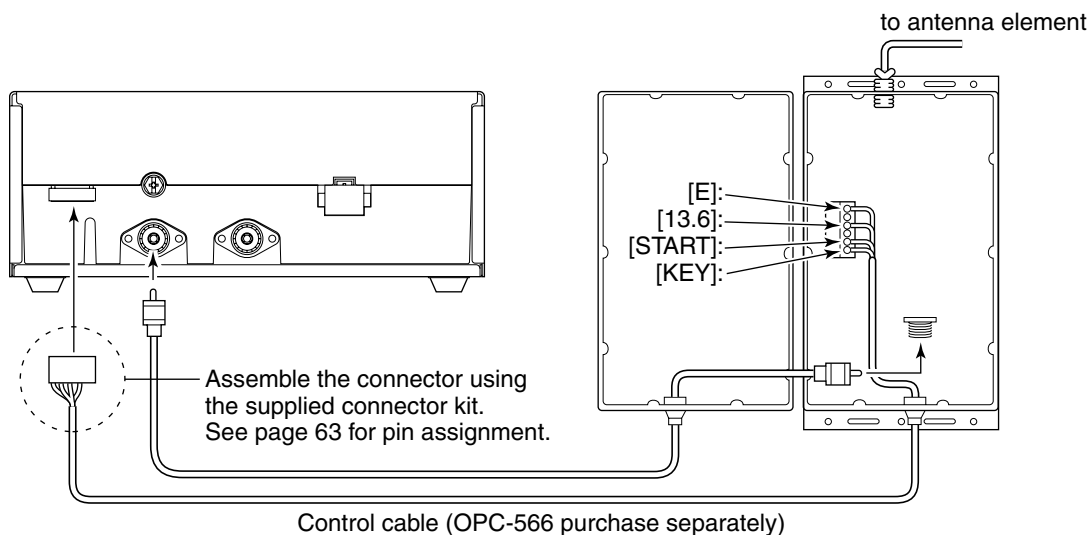

◇ Non-Icom tuner

Some non-Icom tuners may be used with the IC-M802. Please consult your dealer if you wish to connect one.

◇ AT-140 AUTOMATIC ANTENNA TUNER

See page 56.

■ Mounting

◇ Mounting location

Select a location that provides easy access to the controller for navigation safety, has good ventilation and is not subject to sea spray. The controller should be at 90 degrees to your line of sight when operating it.

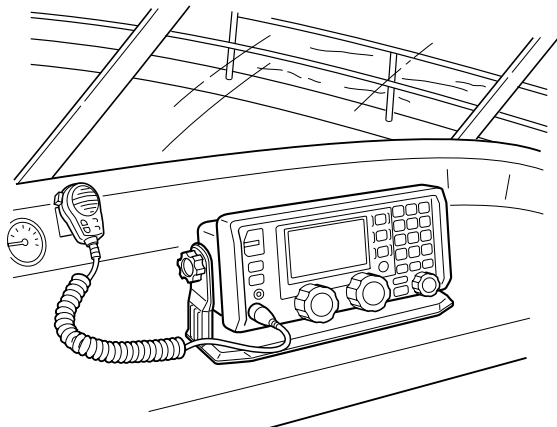

CAUTION: KEEP the transceiver and microphone at least 1 meter away from your ship's magnetic navigation compass.

Check the installation angle; the display may not be easy to read at some angles.

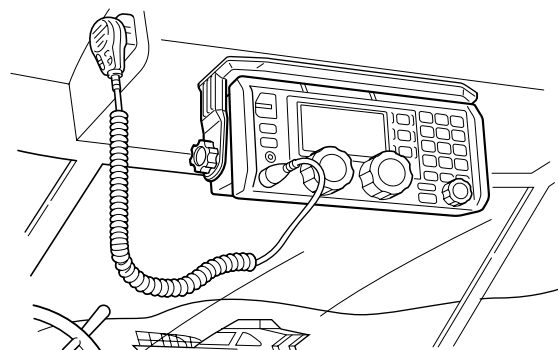

◇ Mounting the controller/speaker/main unit

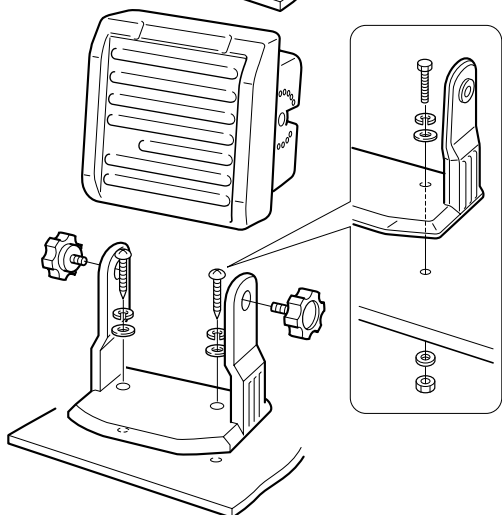
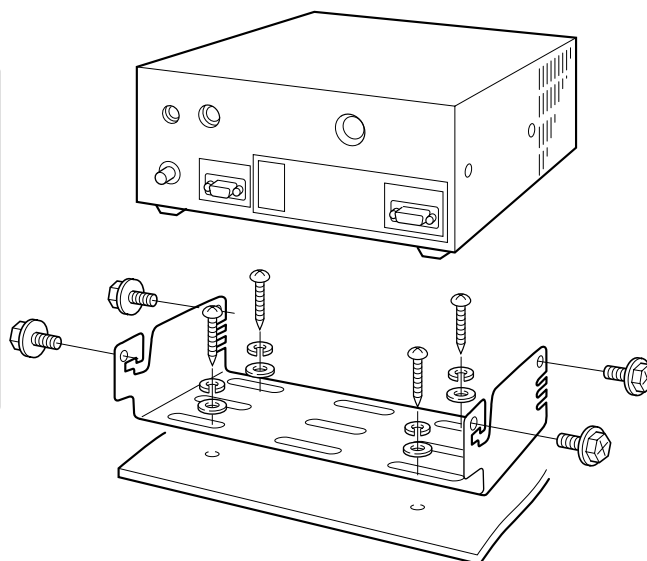
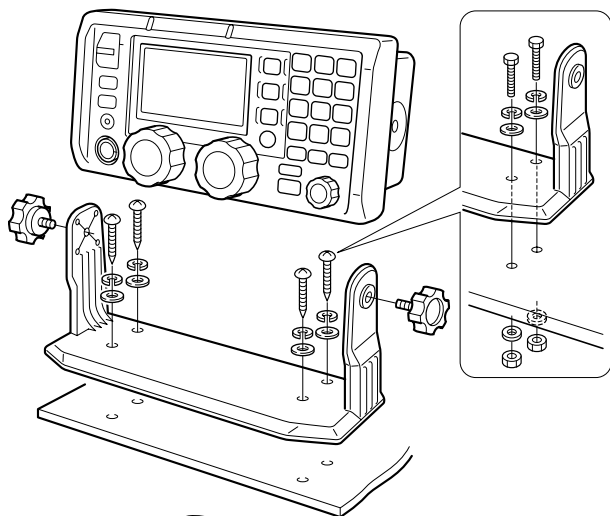

WARNING! NEVER mount the transceiver main unit overhead. The weight of the unit is approximately 4.7 kg (10 lb 6 oz), but its apparent weight will increase several fold due to wave shocks or vibration. The unit must be mounted on a flat hard surface only.

■ Using the optional MB-75

The optional MB-75 flush mount is available for mounting the controller and speaker to a flat surface such as an instrument panel.

CAUTION: KEEP the transceiver and microphone at least 1 meter away from your ship's magnetic navigation compass.

- ① Using the template on the page 67 for the remote controller (RC-25), and page 69 for the speaker (SP-24), carefully cut a hole into the instrument panel (or wherever you plan to mount the controller or the speaker).
- ② Slide the controller or the speaker through the hole as shown below.

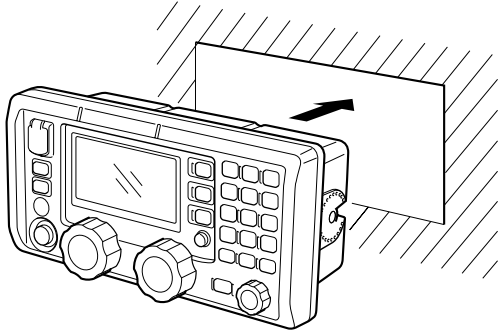

- ③ Attach the supplied 2 screws (M5×8) and spacers on either side of the controller or speaker.
- ④ Attach the clamps on either side of the controller or speaker.
 - Make sure that the clamps align parallel to the body.

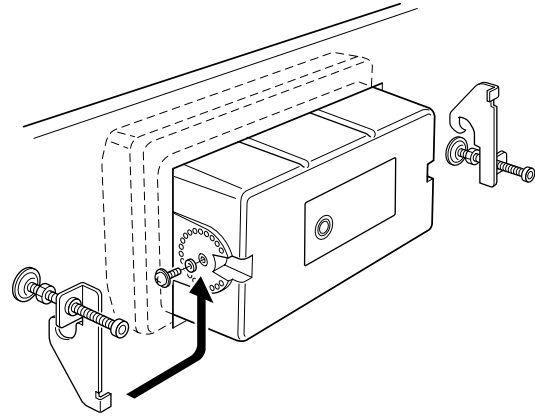

- ⑤ Tighten the end screws on the clamps (rotate clockwise) so that the clamps press firmly against the inside of the instrument control panel.
- ⑥ Tighten the locking nuts (rotate counterclockwise) so that the controller or speaker is securely mounted in position as below.
- ⑦ Connect the control cable then return the instrument control panel to its original place.

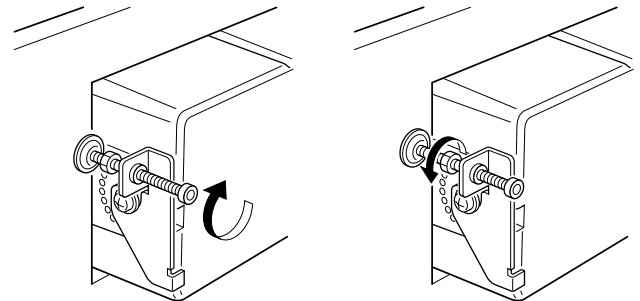

✓ For your reference

When flush mounting the controller and speaker side by side as below, screw and spacer attachment for the facing side will be impossible with the instructions above.

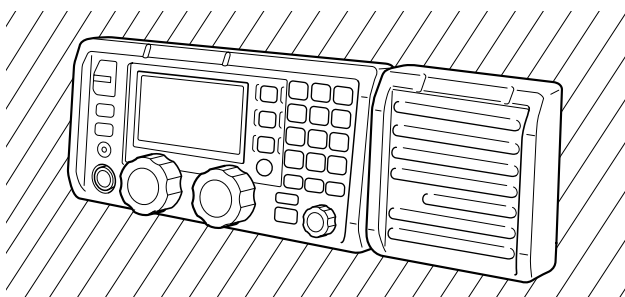

In this case, refer to the instructions at right for reference.

- ① Carefully cut the holes with at least 25 mm (1 in) space between them into the instrument panel.
- ② Install the speaker as instructed above, first.
- ③ Attach the screw and spacer on the speaker side of the controller.
- ④ Slide the controller through the hole as shown below.

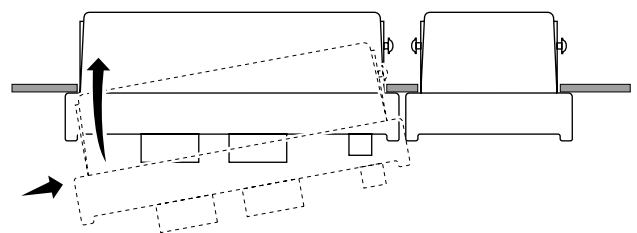

- ⑤ Attach the screw and spacer on the other side of the controller, then attach the clamps and follow steps ⑤ to ⑦ as above.

■ Transceiver dimensions

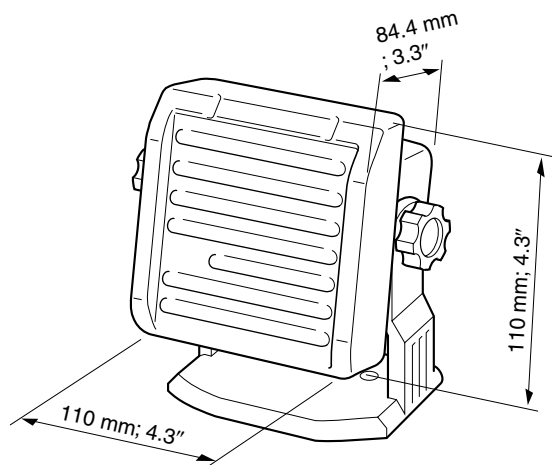
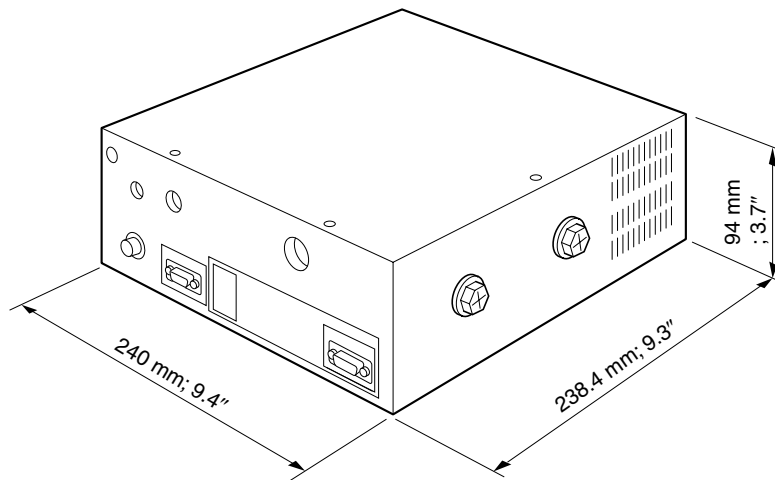
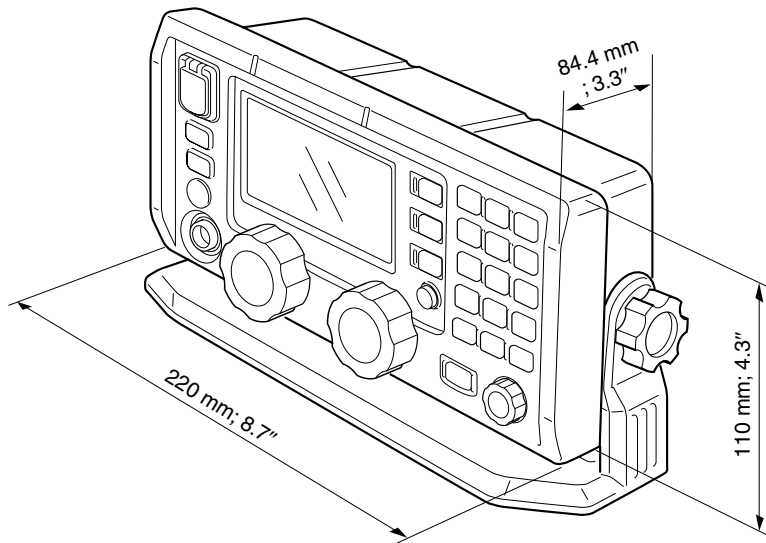

■ Fuse replacement

The transceiver has 2 fuses (2 types) to protect internal circuitry, 1 fuse for the fuse holder on the DC power cable and 1 for inside. If the transceiver stops functioning, check the fuses below.

- DC power cable FGB 30 A
- Circuitry fuse FGB 5 A

CAUTION: DISCONNECT the DC power cable from the transceiver when changing a fuse.

◇ Internal fuse replacement

- ① Unscrew 8 screws from the top cover, then remove the cover.

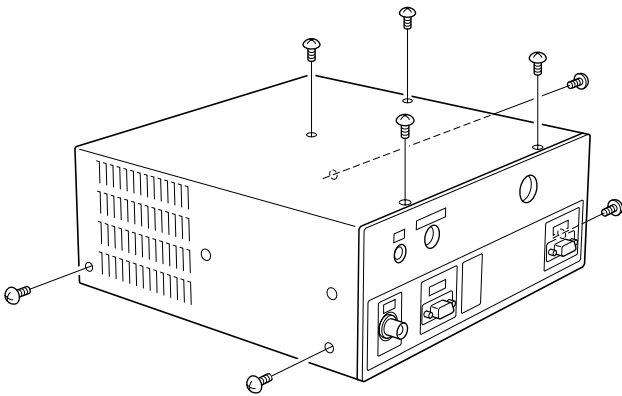

- ② Unscrew 8 screws from the PA shield cover, then open the cover.

- The cooling fan is fixed with the PA shield cover.
- Move the coaxial cable as shown in the diagram.
- Be careful the cooling fan power cables are still connected.

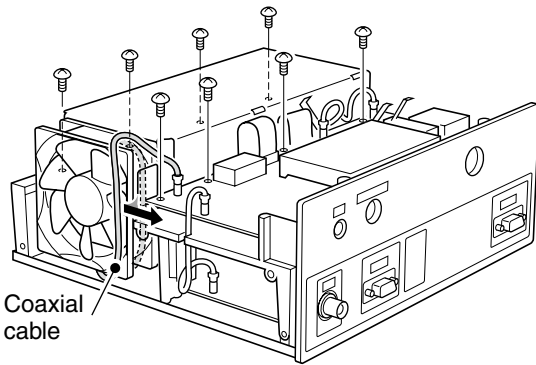

- ③ Replace the circuitry fuse as shown in the diagram below.

- Use the supplied FGB 5 A fuse (glass tube type).

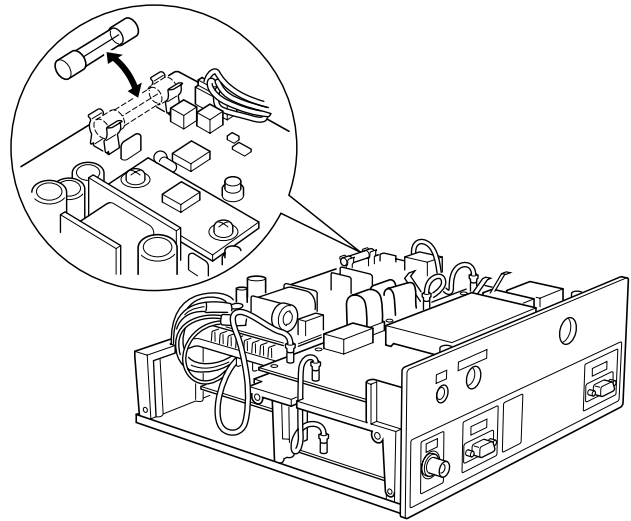

- ④ Attach the PA shield cover, coaxial cable and top cover to their original position.

◇ Line fuse replacement

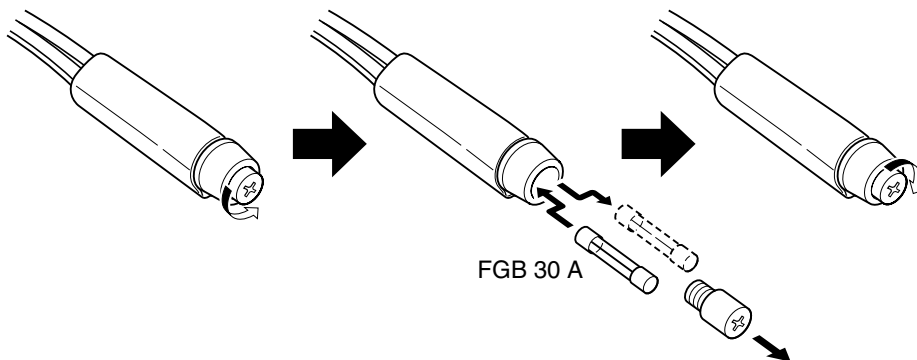

■ Connector information

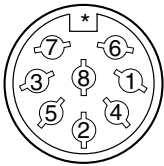
ACC	Pin	Pin name	Description	Specification
	1	CWK	CW and FSK keying input.	Input level : Less than 0.6 V for transmit
	2	AF GND	Ground line for AF signal.	
	3	SEND	Input/output pin. Goes to ground when transmitting. When grounded, transmits.	Ground level : -0.5 to 0.8 V Input current : Less than 20 mA
	4	MOD	Modulator input. Usable when pin 3 is grounded.	Input impedance : 5 kΩ Input level : Approximately 100 mV rms
	5	AF	AF detector output. Fixed, regardless of [VOL] position.	Output impedance: 4.7 kΩ Output level : 100–300 mV rms
	6	NC	No connection.	
	7	13.6 V	13.6 V output when power is ON.	Output current : Maximum 1 A
	8	ALC	ALC voltage input.	Control voltage : -3 to 0 V Input impedance : More than 10 kΩ
	*	DC GND	Common ground.	

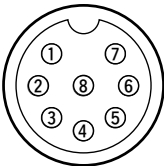
MICROPHONE	Pin	Pin name	Description	Specification
	1	MIC+	Audio input from the mic element.	Input impedance : 2.4 kΩ
	2	NC	No connection.	
	3	AF1	AF output controlled with [VOL].	
	4	AF2	Ground for AF1.	
	5	PTT	PTT switch input.	When grounded, transmits.
	6	GND	Connected to the ground.	
	7	MIC-	Coaxial ground for MIC+.	
	8	AF-	Coaxial ground for AF1 and AF2.	

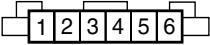
TUNER	Pin	Pin name	Description	Specification
	1	KEY	Key signal input.	-0.5 to 0.8 V during tuning
	2	START	Start/through signal output.	
	3	13.6V	13.6 V output.	
	4	E	Negative terminal.	
	5	NC	No connection.	
	6	NC	No connection.	

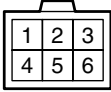
DC 13.6V	Pin	Pin name	Description	Specification
	1-3	⊕	DC input ⊕.	Maximum power consumption 30 A typical.
	4-6	⊖	DC input ⊖.	

■ Connector information (continued)

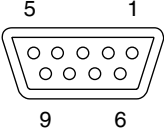
AF/MOD	Pin	Pin name	Description	Specification
	1	MOD+	Modulation input from an external terminal unit.	Input impedance : 600 Ω Input level : Approximately 0.77 V rms
	2	MOD-	Coaxial ground for NMD+.	
	3	GND	Ground for digital equipment.	
	4	NAF+	AF detector output for an external terminal unit.	Output impedance: 600 Ω Output level : 0.25–2.5 V rms
	5	NAF-	Coaxial ground for NAF+.	
	6	GND	Ground for digital equipment.	
	7	NC	No connection.	
	8	SEND	Transmits when grounded.	Output level : –0.5 to 0.8 V Input level : Less than 20 mA
	9	GND	Ground for digital equipment.	

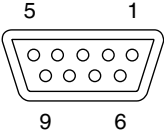
REMOTE	Pin	Pin name	Description
	1	DCD	Input terminal for carrier detection.
	2	RXD	Input terminal for receive data. (“RS-232C” selection for REMOTE IF. (p. 54))
		NMEA-OUT	NMEA0183 ver. 3.01 data output. (“NMEA” selection for REMOTE IF. (p. 54))
	3	TXD	Outputs transmit data. (“RS-232C” selection for REMOTE IF. (p. 54))
		NMEA-IN	NMEA0183 ver. 3.01 data input. (“NMEA” selection for REMOTE IF. (p. 54))
	4	DTR	Outputs data terminal ready signal.
	5	GND	Connected to the ground.
	6	DSR	Input terminal for data-set-ready signal.
	7	RTS	Outputs request-to-send data.
8	CTS	Input terminal for clear-to-send data.	
9	NC	No connection.	

GPS	Pin	Pin name	Description
	1	NMEA ⊕	NMEA0183 ver 3.01 (sentence formatter: GGA) data input ⊕.
	2	NMEA ⊖	Ground for NMEA data.

• General

- Frequency coverage : (Unit: MHz)

Receive	0.5–29.9999	
Transmit	1.6–2.9999	4.0–4.9999
	6.0–6.9999	8.0–8.9999
	12.0–13.9999	16.0–17.9999
	18.0–19.9999	22.0–22.9999
	25.0–27.5000	
- DSC channels : 2,187.5 kHz, 4,207.5 kHz, 6,312.0 kHz, 8,414.5 kHz, 12,577.0 kHz, 16,804.5 kHz
- Type of emission :

Transceiver	J3E (USB/LSB), H3E,* J2B (AFSK), F1B (FSK), A1A (CW)
DSC receiver	J2B

*Receive only
- Number of memory Channels:

1355 channels (maximum)
160 user programmable, 249 ITU SSB duplex, 124 ITU SSB simplex, 662 ITU FSK duplex and 160 e-mail channels
- Antenna connector : SO-239×2 (50 Ω)
- Usable temperature range: –30°C to +60°C ; –22°F to +140°F (Specifications guaranteed –20°C to +55°C range only.)
- Frequency stability (–20°C to +55°C):

Transceiver	±10 Hz
DSC receiver	±10 Hz

(Approximately 5 minutes after battery connection)
- Power supply : 13.6 V DC ±15% (negative ground)
- Current drain :

Transmit	at maximum power 30 A typical
Receive	at maximum audio 3.0 A
- Dimensions (projections not included):

Main unit	240(W)×94(H)×238.4(D) mm
	; 9.4(W)×3.7(H)×9.4(D) in
Controller (RC-25)	220(W)×110(H)×84.4(D) mm
	; 8.7(W)×4.3(H)×3.3(D) in
Speaker (SP-24)	110(W)×110(H)×84.4(D) mm
	; 4.3(W)×4.3(H)×3.3(D) in
- Weight (approximately) :

Main unit	4.7 kg; 10 lb 6 oz
Controller (RC-25)	570 g; 1 lb 4 oz
Speaker (SP-24)	370 g; 13 oz
- Accessory connector : 8-pin DIN connector
- CONTROLLER connector: 8-pin MINI DIN connector
- GPS connector : BNC connector (NMEA0183 ver. 3.01, sentence formatter: GGA)
- REMOTE connector : D-sub 9-pin (RS-232C/NMEA)
- AF/MOD connector : D-sub 9-pin

• Transmitter

- Output power :

1.6–27.5000 MHz	150/60/20 W p-p
-----------------	-----------------
- Spurious emission : –62 dB
- Carrier suppression : 40 dB below peak output power
- Unwanted sideband : 55 dB below peak output power suppression
- Microphone connector : 8-pin connector (2.4 kΩ)

• Receiver

- Sensitivity :

Transceiver	
J3E, A1A	30 dBμV emf (0.5–1.5999 MHz)
(20 dB SINAD)	13 dBμV emf (1.6–1.7999 MHz)
	8 dBμV emf (1.8–29.9999 MHz)
J2B, F1B	13 dBμV emf (1.6–1.7999 MHz)
(20 dB SINAD)	8 dBμV emf (1.8–29.9999 MHz)
H3E	44 dBμV emf (0.5–1.5999 MHz)
(20 dB SINAD)	30 dBμV emf (1.6–1.7999 MHz)
	24 dBμV emf (1.8–3.9999 MHz)
DSC receiver	0 dBμV emf (all channels)
- Spurious response rejection ratio:

Transceiver	
More than 70 dB (0.5–29.9999 MHz)	
DSC receiver	
More than 60 dB (1st image)	
More than 50 dB (except 1st image)	
- AF output power : More than 4.0 W at 10% distortion with a 4 Ω load (at 13.6 V DC)
- CLARITY variable range: ±150 Hz
- Headphone connector : 3-conductor 3.5 (d) mm (0.1")
- SP connector : 2-conductor 3.5 (d) mm (0.1")/4 Ω

15 OPTIONS

AT-130/E AUTOMATIC ANTENNA TUNER



Matches the transceiver to a long wire antenna with a minimum of insertion loss.

AT-140 AUTOMATIC ANTENNA TUNER



Antenna and control cable receptacles for easy installation and tuner through function are available.

AH-710 FOLDED DIPOLE ANTENNA

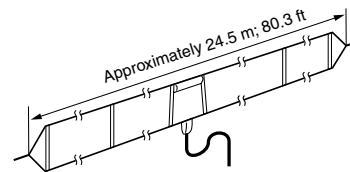

Covers from 1.9 to 30 MHz band. Has an SO-239 connector. Easy to assemble (non-kink construction).

MN-100 ANTENNA MATCHER



Match the transceiver to a dipole antenna. Covers all HF bands from 1.5 to 30 MHz. 8 m (26.2 ft.) × 2 antenna wires are included.

MN-100L ANTENNA MATCHER



Match the transceiver to a long wire antenna. Covers all HF bands from 1.5 to 30 MHz. 15 m (49.2 ft.) × 1 antenna wire is included.

RC-25 REMOTE CONTROLLER

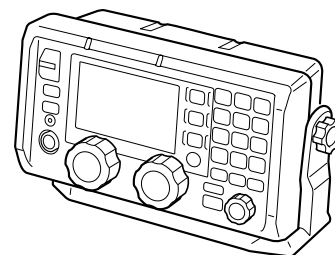

Same as that supplied remote with the transceiver. Mounting bracket, MB-81, is supplied with the controller.

SP-24 EXTERNAL SPEAKER



Same as that supplied with the transceiver. Mounting bracket, MB-82 is supplied with the speaker. Maximum AF input/impedance: 5 W/4 Ω

HM-135 HAND MICROPHONE



Same as that supplied with the IC-M802.

MB-75 FLUSH MOUNT KIT

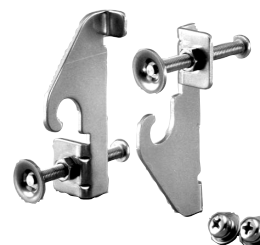

For mounting the remote controller (RC-25) or the SP-24 to a panel.

OPC-1147/N SHIELDED CONTROL CABLE

Shielded control cable protects the transceiver from RF feedback and extends the separation between AT-140 and transceiver up to 10 m (32.8 ft.).

Approved Icom optional equipment is designed for optimal performance when used with an Icom transceiver. Icom is not responsible for the destruction or damage to an Icom transceiver in the event the Icom transceiver is used with equipment that is not manufactured or approved by Icom.

■ Remote controller (RC-25)

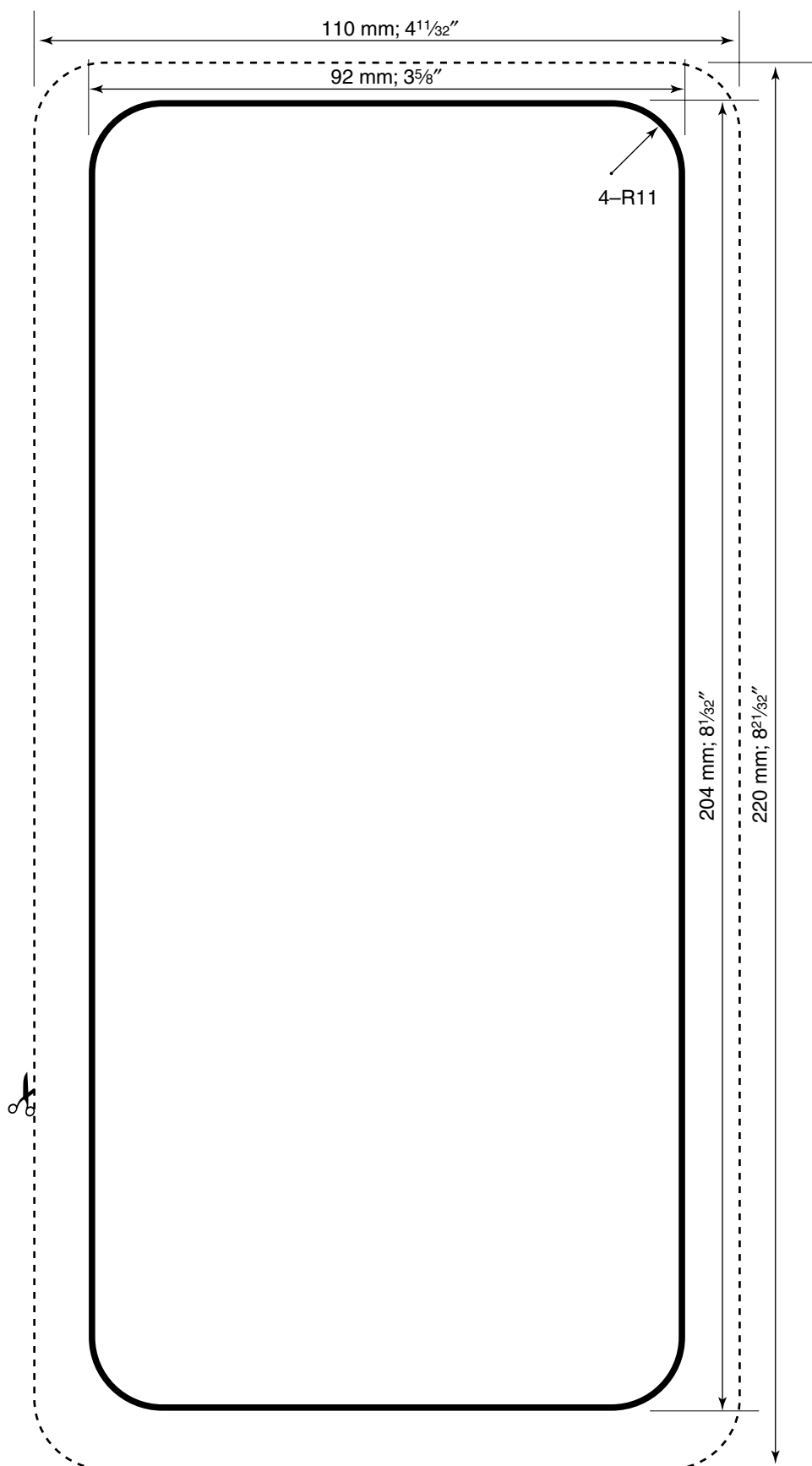

■ Speaker (SP-24)

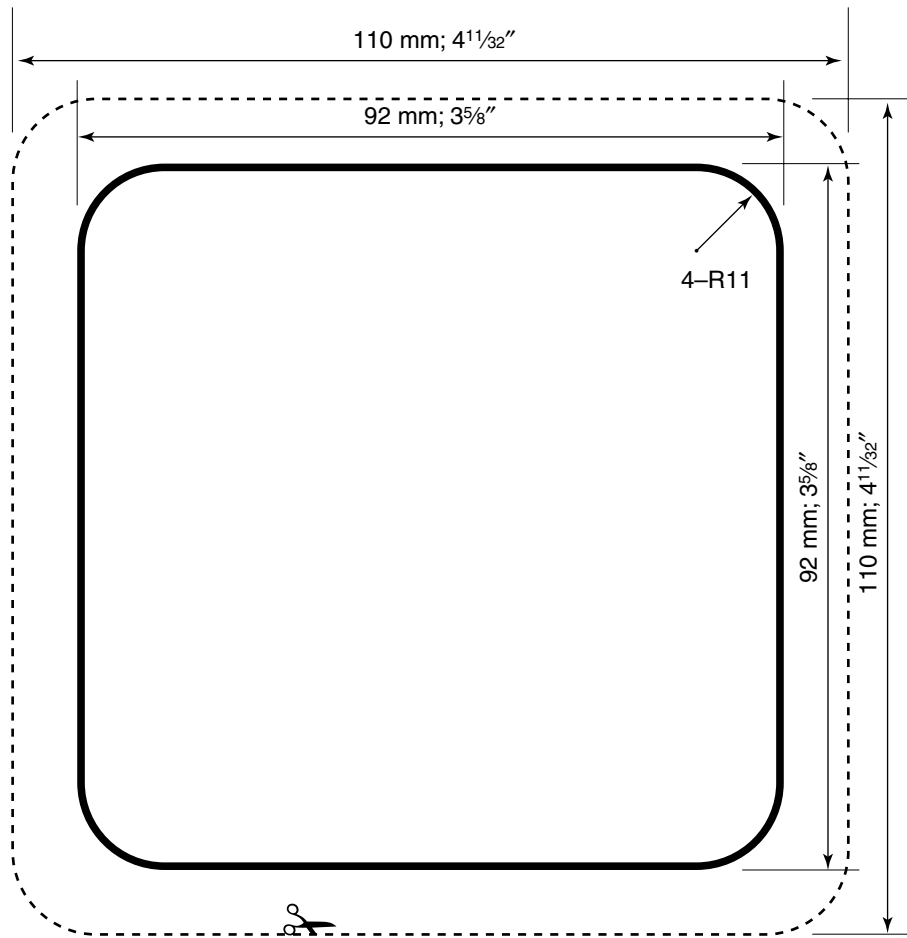

<Cut here>

Count on us!

